



## INSTALLATION INSTRUCTIONS & MANUAL FOR MAINTENANCE

# CORNER BELL SMALL 3 CF/LF

Gas fires with closed combustion system

Bellfires wishes you many cosy evenings with your new Bellfires gas fire

This document is an essential part of your gas fire.  
Read it carefully before installation and maintenance of the  
gas fire and keep it in a safe place!



Serial number:  
Production date:



**BELLFIRES GAS FIRE WITH CLOSED COMBUSTION SYSTEM:**

Corner Bell Small 3 L/R CF (Centre Fire) (CBS3 L/R CF)

Corner Bell Small 3 L/R LF (Line Fire) (CBS3 L/R LF)



# CONTENTS

	Page
1. INSTALLATION INSTRUCTIONS .....	7
2. MAINTENANCE .....	72
3. FAULTS .....	73
4. DISMANTLING / ASSEMBLING OF THE GLASS .....	74
5. DIAGRAM ELECTRICITY AND GAS .....	79
6. DIMENSIONS .....	80
7. TECHNICAL DETAILS/REGULATIONS .....	85
8. REPLACEMENT PARTS LIST .....	89
9. DISPOSAL OF PACKAGING AND APPLIANCE .....	92

**IMPORTANT**



**The installation must only be carried out by a  
“Gas Safe Register” registered installation engineer.**



## 1 INSTALLATION INSTRUCTIONS

### 1.1 GENERAL

The gas fire must be positioned and connected as a “room sealed system” (balance flue) appliance by a “Gas Safe Register” registered gas installation engineer in accordance with the following installation instructions, nationally and locally applicable regulations (see “Technical Details/ Regulations” at the rear of this manual). If you have any queries regarding the installation, please consult your local gas company.

**Important:** **Before beginning the installation, check that the details on the rating plate correspond to the gas type and pressure to which the appliance will be connected.**



The appliance is supplied with a “Centre Fire” or “Line Fire” double burner, as ordered. These burners each have their own specific flame image which is defined by the perforation pattern in the burner cover. See Chapter 5 and the Instructions for use.

The appliance is factory set to the correct nominal heat input. The pilot light is set to the correct level of consumption.

Depending on the requested version, the appliance will be delivered from the factory with a Ø100 mm - Ø150 mm or Ø130 mm - Ø200 mm concentric connection for extracting the flue gases and supply of combustion air.

It is possible to install the gas fire with either a wall or roof outlet.

The roof connection must be carried out using the concentric flue system Ø100 mm - Ø150 mm. The fumes are exhausted naturally to the outside environment through the inner Ø100 mm pipe whereas the combustion air supply passes between the Ø100 mm and Ø150 mm pipes.

The wall connection must be carried out using the concentric flue system Ø130 mm - Ø200 mm. The flue gases are evacuated outside by means of natural draft through the internal pipe of Ø130 mm, whereas the combustion air is supplied between the pipes of Ø130 mm and Ø200 mm.

The wall outlet itself is, depending on the concentric flue gas system configuration, Ø100 mm - Ø150 mm or Ø130 mm - Ø200 mm.

The gas fire can be installed in a completely sealed or mechanically ventilated house without extra ventilation and/or fume extraction.

The gas fire can be installed as an **insertion** into an existing open fire place or as a **built-in** appliance in a new fire place.

**In order to prevent the fireplace heating up excessively, it must be properly ventilated** by installing vents at the top and bottom of the fireplace.

The appliance can be fitted with a convection package as an optional extra. This is a “convection jacket” (convection casing) for around and above the appliance, two flexible aluminium pipes and two built-in convection vents. This enables hot air to be circulated into the room.

If required, two additional convector grills can be fitted (= 1x extra convection set).

If an existing chimney is to be used, please consult your installer first. If the chimney was previously used for a wood or coal fire, then it should be cleaned by an expert.

## 1.2 CONCENTRIC FLUE SYSTEMS Ø100 MM - Ø150 MM AND Ø130 MM - Ø200 MM :

- **Bellfires (Muelink & Grol system)**
- **Poujoulat (PGI system)**
- **Ontop (Metaloterm US system)**

The gas fire, in combination with the concentric flue system [Ø100 mm - Ø150 mm] and/or [Ø130 mm - Ø200 mm] (rigid and/or flexible) for the brands Bellfires (Muelink & Grol system), Poujoulat (PGI system) or Ontop (Metaloterm US system), has been approved in accordance with the European CE-norm for gas appliances and may therefore be used only with these systems. The permitted components for these systems are listed in Chapter 1.6.2. The guarantee on the appliance lapses if it is installed, fully or partially, with other components or a different flue system.

The concentric flue [Ø100 mm - Ø150 mm] and [Ø130 mm - Ø200 mm] systems can be used with either a newly-built or existing chimney.

## 1.3 INCLUDED

Set documentation	<ul style="list-style-type: none"> <li>- Instructions for use</li> <li>- Installation instructions</li> </ul>
Attributes	<ul style="list-style-type: none"> <li>- Ceramic log set, or marble pebbles white or marble pebbles grey</li> </ul>

N.B. If any part is missing, please contact your dealer.



## 1.4 OPTIONS AND ACCESSORIES

The following options and accessories can be supplied by your dealer:

<u>Part no</u>	<u>Option</u>
334353 334352 312829	<u>Convection package Corner Bell Small 3 L</u> <ul style="list-style-type: none"> <li>• 1x Convection casing</li> <li>• 1x Convection top plate L</li> <li>• 1x Convection set General</li> </ul>
334353 334362 312829	<u>Convection package Corner Bell Small 3 R</u> <ul style="list-style-type: none"> <li>• 1x Convection casing</li> <li>• 1x Convection top plate R</li> <li>• 1x Convection set General</li> </ul>
334365 334367	Mantle iron CBS3 L Mantle iron CBS3 R
..... .....	10 cm Frame 4 sided CBS3L (incl. mantle iron CBS3L) 10 cm Frame 4 sided CBS3R (incl. mantle iron CBS3R)
334371 334372	Black mirror rear wall CBS3 L/R / VWBS3 Black mirror side wall CBS3 L/R
334351 (3x)	Fins rear wall CBS3 L/R / VWBS3

<u>Part no</u>	<u>Accessorie</u>
312829 302188 310178 309872 309730 304040	<u>Convection set General:</u> (for convection air extraction) <ul style="list-style-type: none"> <li>• 1x Flexible aluminium pipe Ø125 mm, L= 3 m (max.)</li> <li>• 2x Fitting box 135 x 135 mm</li> <li>• 2x Convection exit grid, white, 145 x 145 mm</li> <li>• 2x Collar adaptor Ø125 mm</li> <li>• 4x Hose clamp Ø125 mm</li> </ul>
329874	Set carrying brackets (2 pieces)
3.....	Bellfires (M&G) concentric flue system See component summary
3.....	Poujoulat (PGI) concentric flue system See component summary
3.....	Ontop (Metaloterm US) concentric flue system See component summary

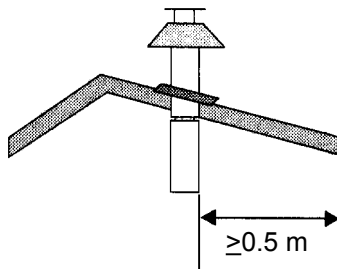
## 1.5 PREPARATION FOR INSTALLATION

The following preparation must be carried out before the gas fire can be installed.

### 1.5.1 Instructions for positioning the outlet

#### 1.5.1.1 Positioning the outlet for correct operation:

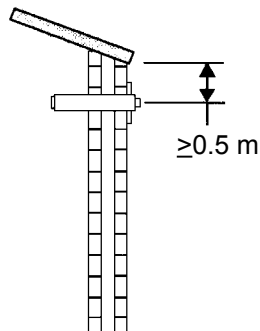
Roof-mounted outlet:



**Figure 1: Roof-mounted outlet**

This must be positioned at least 0.5 m from the roof edge; the apex of the roof can be disregarded.

Wall-mounted outlet:



**Figure 2: Wall-mounted outlet**

This must be positioned at least 0.5 m from:

- the corner of the building.
- the roof overhang, the rain gutter.
- balconies etc., unless the exhaust construction extends to at least the face of the protruding section.

### 1.5.1.2. Positioning the outlet to avoid affecting the surrounding area



All listed “distances” in this section are no more than guidelines.  
For the exact minimum “distances”, please consult your national and local directives.

“Distance” = minimum distance required for positioning of the outlet to avoid adverse effects with respect to:

- A. A ventilation opening serving an occupied room, a toilet or a bathroom.
- B. A heating air supply, when the supply flows through an occupied room.
- C. A window that can be opened and that is near an occupied room, a toilet or a bathroom.

#### **Roof-mounted outlet:**

<u>To avoid adverse effects</u>	<u>Distance: outlet - A, B or C</u>
At the same roof level.	>3 m (*)
At a different roof level.	>1 m (*)
At a lower positioned wall.	>1 m
At a higher sloping surface.	>3 m (**)

(\*) If the required distance cannot be achieved, the outlet position rules take precedence.

(\*\*) If the required distance cannot be achieved, the position of the outlet must be at least 1 m above the highest facade/roof.

**Wall-mounted outlet:**

<u>To avoid adverse effects</u>	<u>Distance: outlet - A, B or C</u>
At walls in buildings with staggered heights.	Not permitted if A, B, or C are located above the outlet.
On a wall - general. (*)	Above the outlet: >2 m Below the outlet: >0.75 m Left and right of the outlet: >0.75 m
At <1 m from the roof overhang.	>2 m
Beneath balconies, walkways etc.	>2 m from the underside of the protruding balcony or walkway.
Beneath balconies, walkways etc. where the outlet extends to the front.	>2 m
To the garden or on the terrace.	>2 m to the outside space. (**)
With respect to a facing wall.	>2 m (if the distance from the facing wall is less, the criteria detailed for "On a wall - general" apply).
Enquire at your local gas company for the regulations relating to outlets positioned opposite each other and outlet(s) in facade(s) that form an angle.	

(\*) These minimum distances do not apply if there is an obstruction between the outlet and A, B and C that protrudes at least 0.5 m from the wall and has a length exceeding the distance.

(\*\*) This distance is not required if the outlet is situated at least 1 m higher than the intended area of the outside space.

If the outlet has a clearance of less than 0.5 m from the hard surface of a public area at a height of less than 2 m, it must be fitted with an effective protector. The mesh size of the guard must not affect the correct operation of the appliance.

## 1.6 GENERAL SERVICES

### 1.6.1 The Fume Channel/Combustion Air Intake

The combined fume channel and combustion air intake requires one of the following concentric flue system configurations.

**Important:**

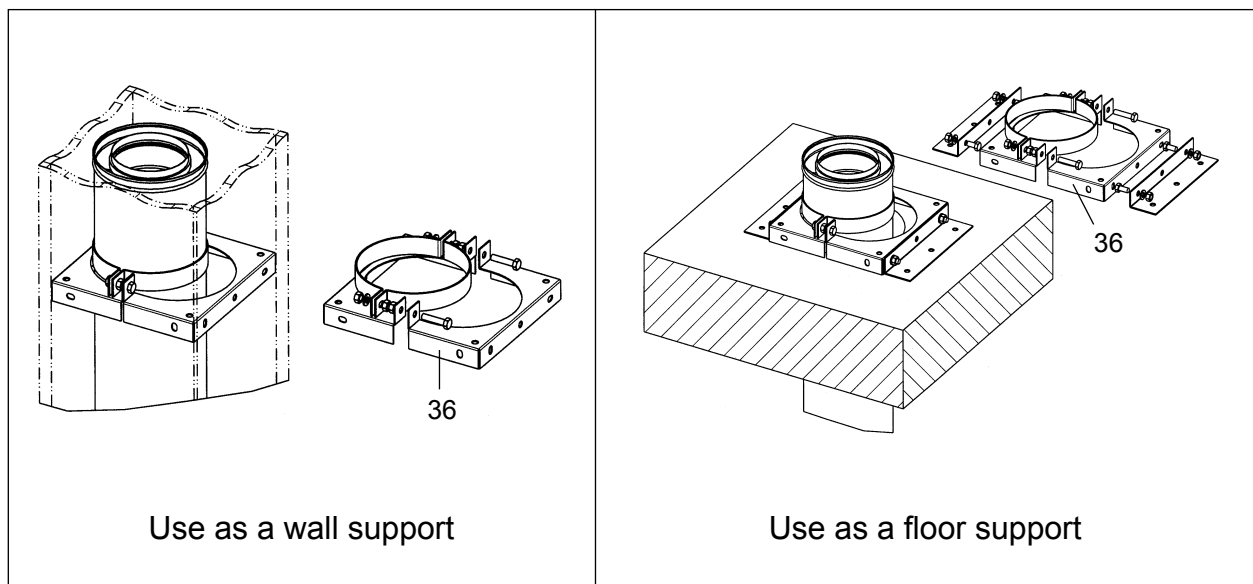


**Due to the high temperature of the outer walls (approx. 150°C), no flammable materials may be located or used in the vicinity of the flue system. The complete flue system, must therefore be sleeved with a heat resistant material after assembly.**

**Ventilate the covered concentric flue by fitting a grid near the floor and ceiling (on each floor).**

**Do not insulate the concentric flue.**

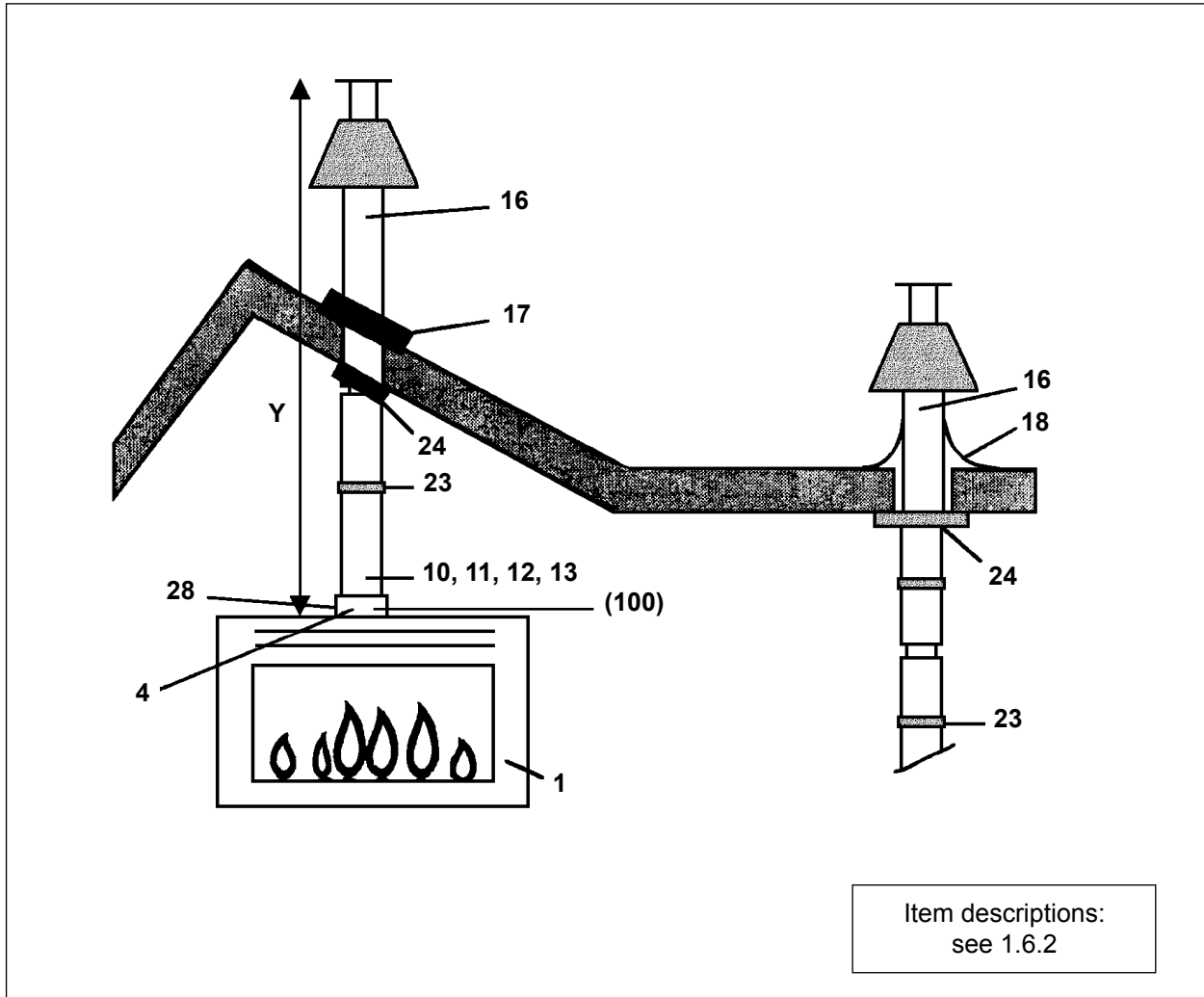
**Use the universal wall/floor support Ø150 mm to attach the covering of the concentric flue system [Ø100 mm - Ø150 mm], see 1.6.2, drawing number 36.**



**Figure 3: Application universal wall/floor support Ø150 mm**

**RIGID CONCENTRIC FLUE Ø100 mm - Ø150 mm SYSTEM CONNECTION POSSIBILITIES**

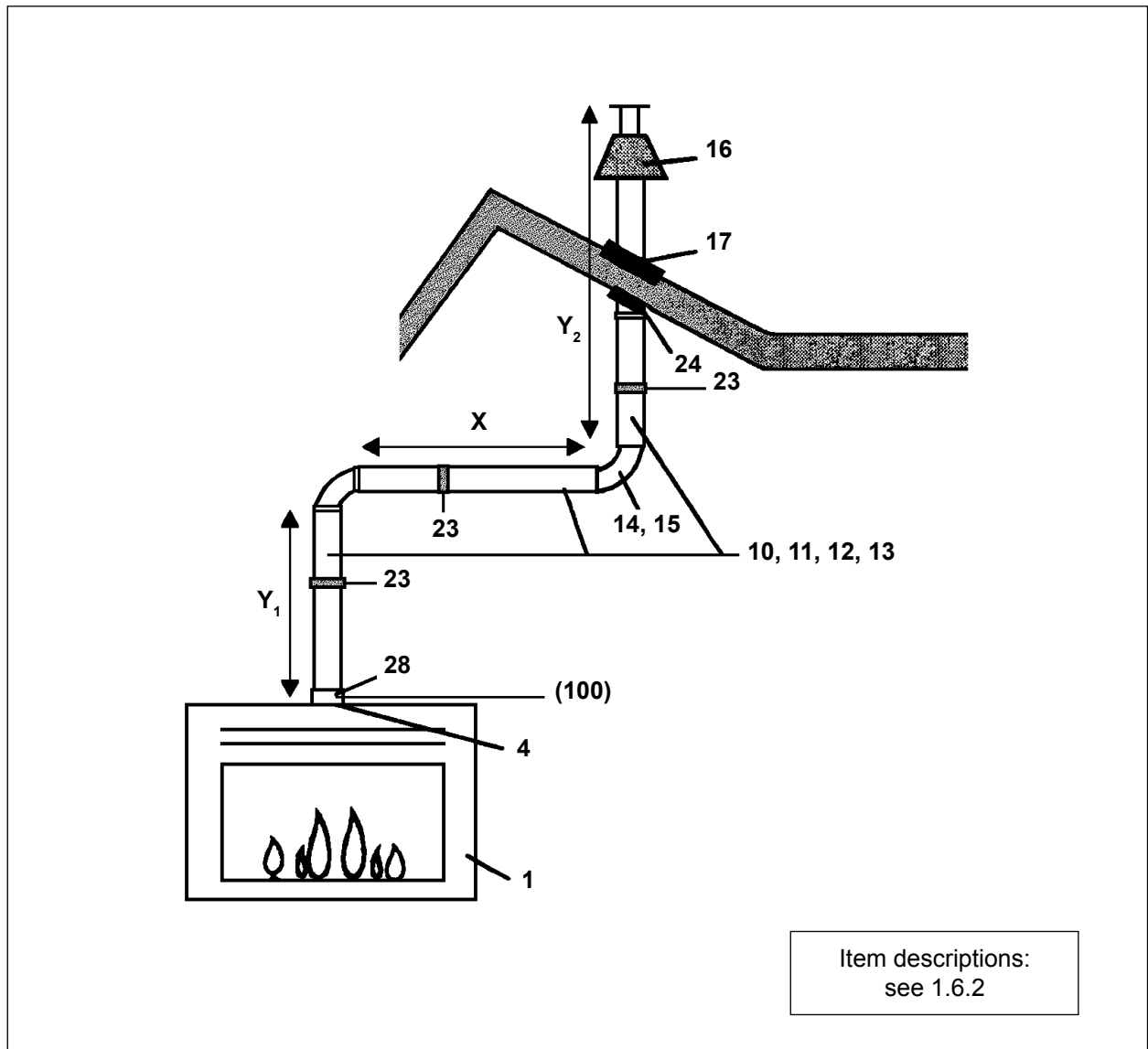
**Appliance: Concentric flue connection Ø100-Ø150 mm or Ø130-Ø200 mm**



Appliance:	Distance Y (min.-max.)	Assemble restriction plate:	
		Concentric connection on appliance is Ø100-Ø150 mm	Concentric connection on appliance is Ø130-Ø200 mm
Corner Bell Small 3 L/R	2.0 - 4.0 m	Width: B = 30 mm	Width: B = 65 mm
	4.0 - 12.0 m	Width: B = 40 mm	Width: B = 80 mm

**Figure 4: Vertical roof-mounted outlet without bend**

ALL SIZES INCLUDE THE LENGTH OF THE ROOF OR WALL TERMINATION



Appliance:	Distance $Y_1$ (*) (min.-max.)	Distance X (*) (min.-max.)	Distance $Y_1 + Y_2$ (*) (min.-max.)	Assemble restriction plate:	
				Concentric connection on appliance is $\varnothing 100$ - $\varnothing 150$ mm	Concentric connection on appliance is $\varnothing 130$ - $\varnothing 200$ mm
Corner Bell Small 3 L/R	1.0 - 11.0 m	0 - 3.0 m	1.0 - 11.0 m	-	Width: B = 40 mm

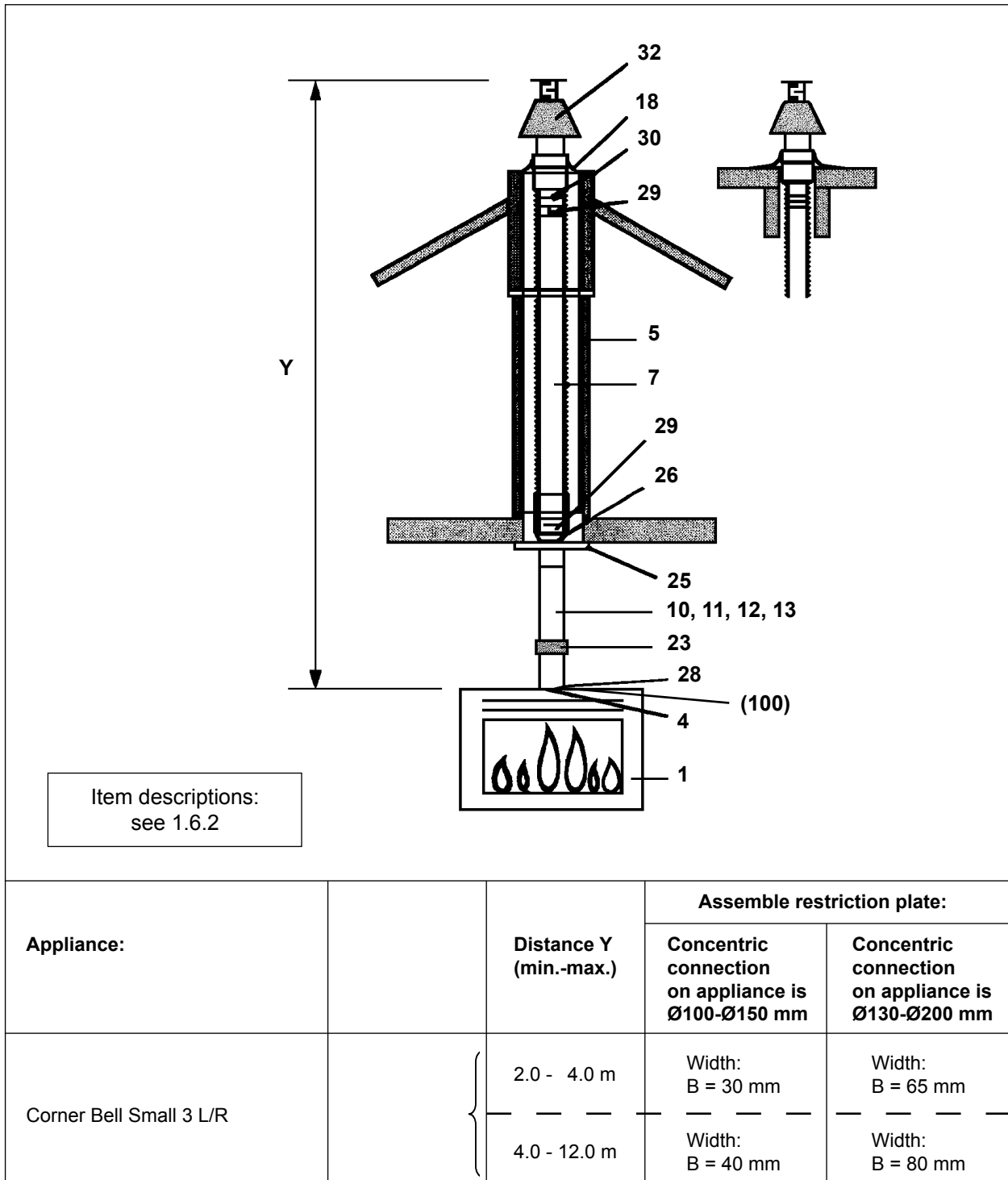
(\*) :  $(Y_1 + Y_2) : X \geq 2 : 1$   
(Vertical to horizontal ratio (or 45° upwards) is always at least 2 to 1)

**Figure 5: Vertical roof-mounted outlet with bend**

ALL SIZES INCLUDE THE LENGTH OF THE ROOF OR WALL TERMINATION

**FLEXIBLE CONCENTRIC FLUE Ø100 mm - Ø150 mm SYSTEM CONNECTION POSSIBILITIES**

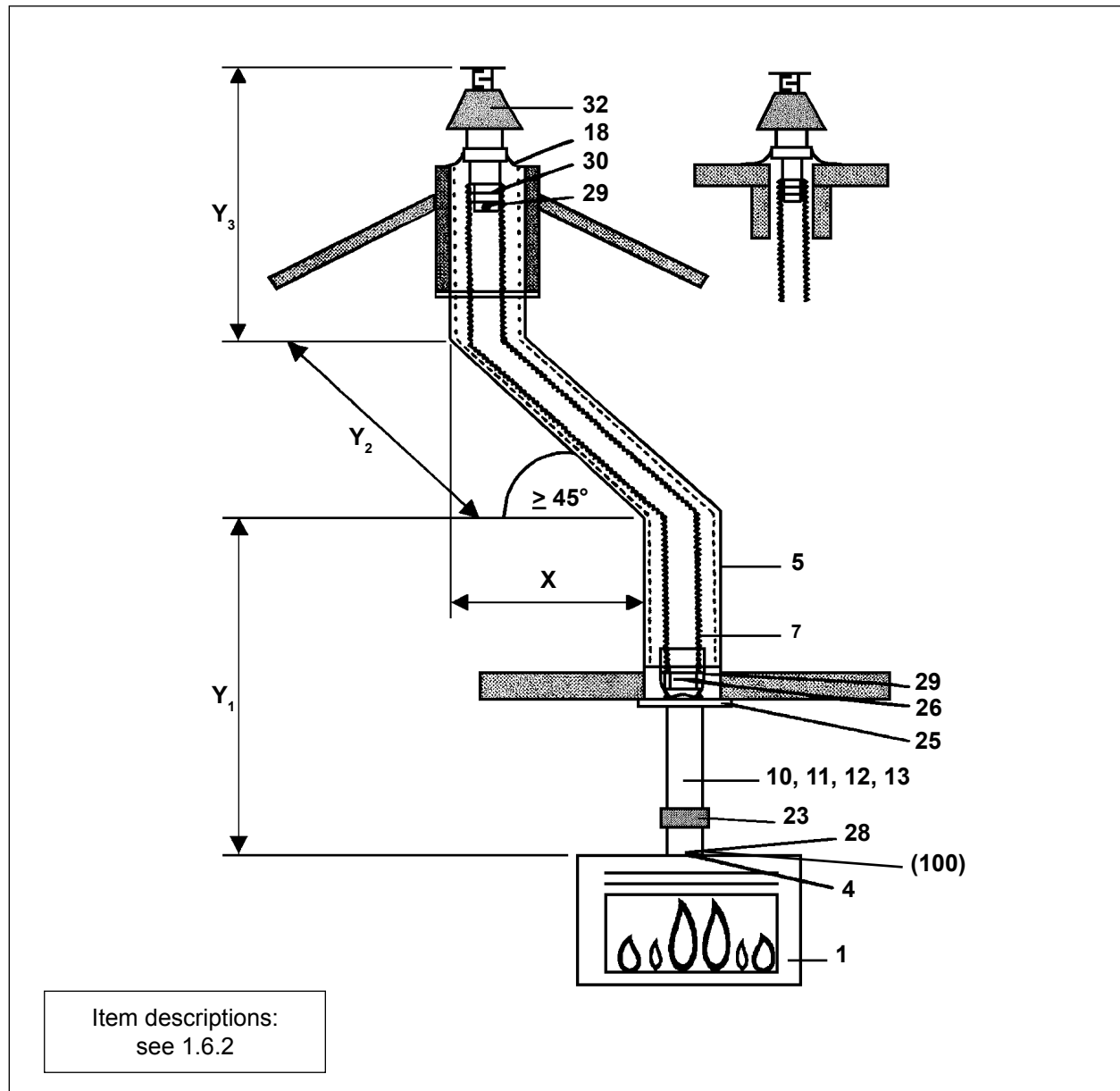
**Appliance: Concentric flue connection Ø100-Ø150 mm or Ø130-Ø200 mm**



**Figure 6: Vertical chimney outlet using an existing lined chimney**  
 (Flexible Ø100 mm and/or rigid Ø100 mm / Ø150 mm)

ALL SIZES INCLUDE THE LENGTH OF THE ROOF OR WALL TERMINATION



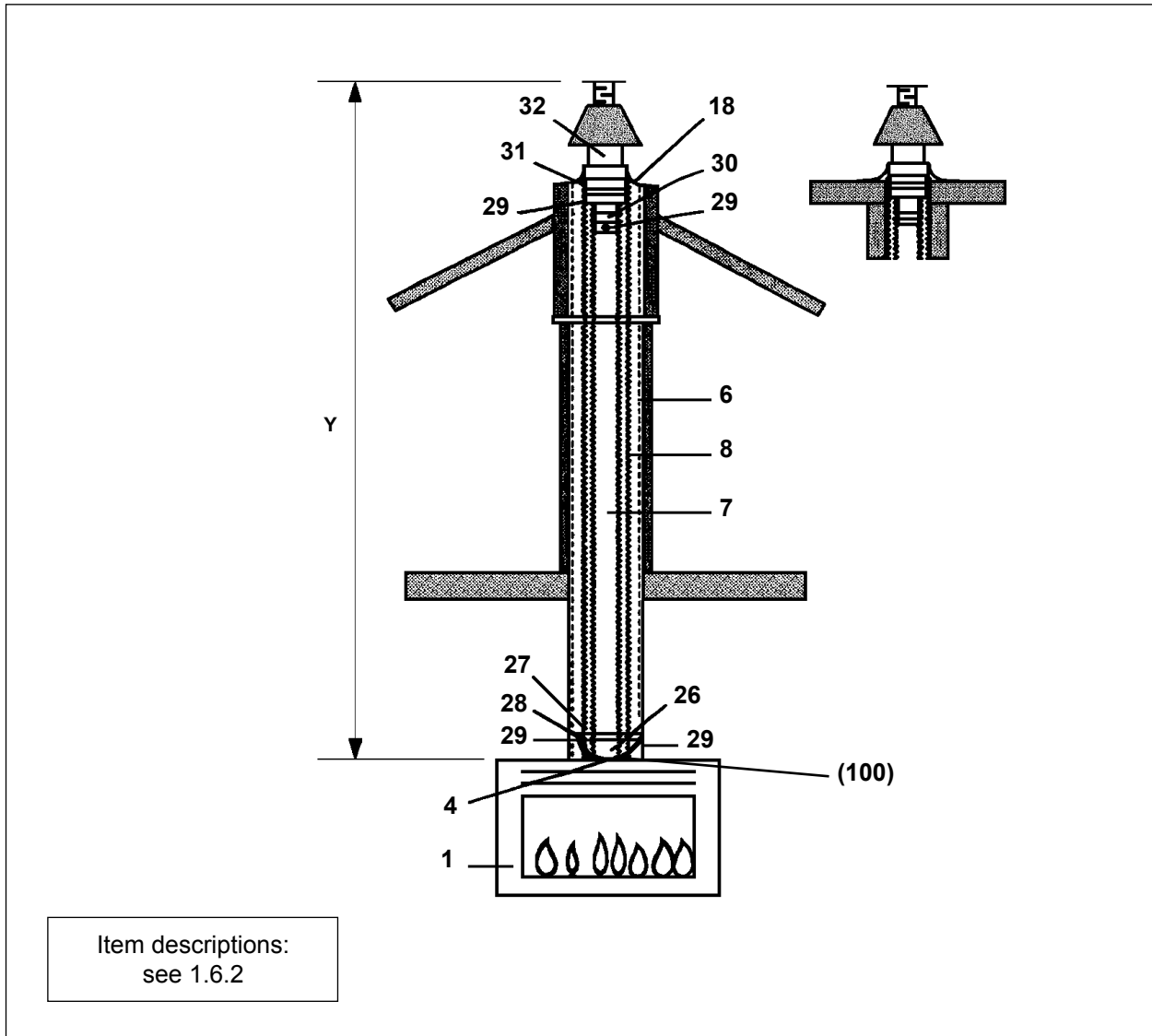


Appliance:	Distance Y <sub>1</sub> (*) (min.-max.)	Distance X (*) (min.-max.)	Distance Y <sub>1</sub> + Y <sub>2</sub> + Y <sub>3</sub> (*) (min.-max.)	Assemble restriction plate:	
				Concentric connection on appliance is Ø100-Ø150 mm	Concentric connection on appliance is Ø130-Ø200 mm
Corner Bell Small 3 L/R	1.0 - 11.0 m	0 - 3.0 m	1.0 - 11.0 m	-	Width: B = 40 mm

(\*) : (Y<sub>1</sub> + Y<sub>2</sub> + Y<sub>3</sub>) : X ≥ 2 : 1  
 (Vertical to horizontal ratio (or 45° upwards) is always at least 2 to 1)

**Figure 7: Vertical chimney outlet using a lined chimney with a bend ≥ 45°**  
 (Flexible Ø100 mm and/or rigid Ø100 mm / Ø150 mm)

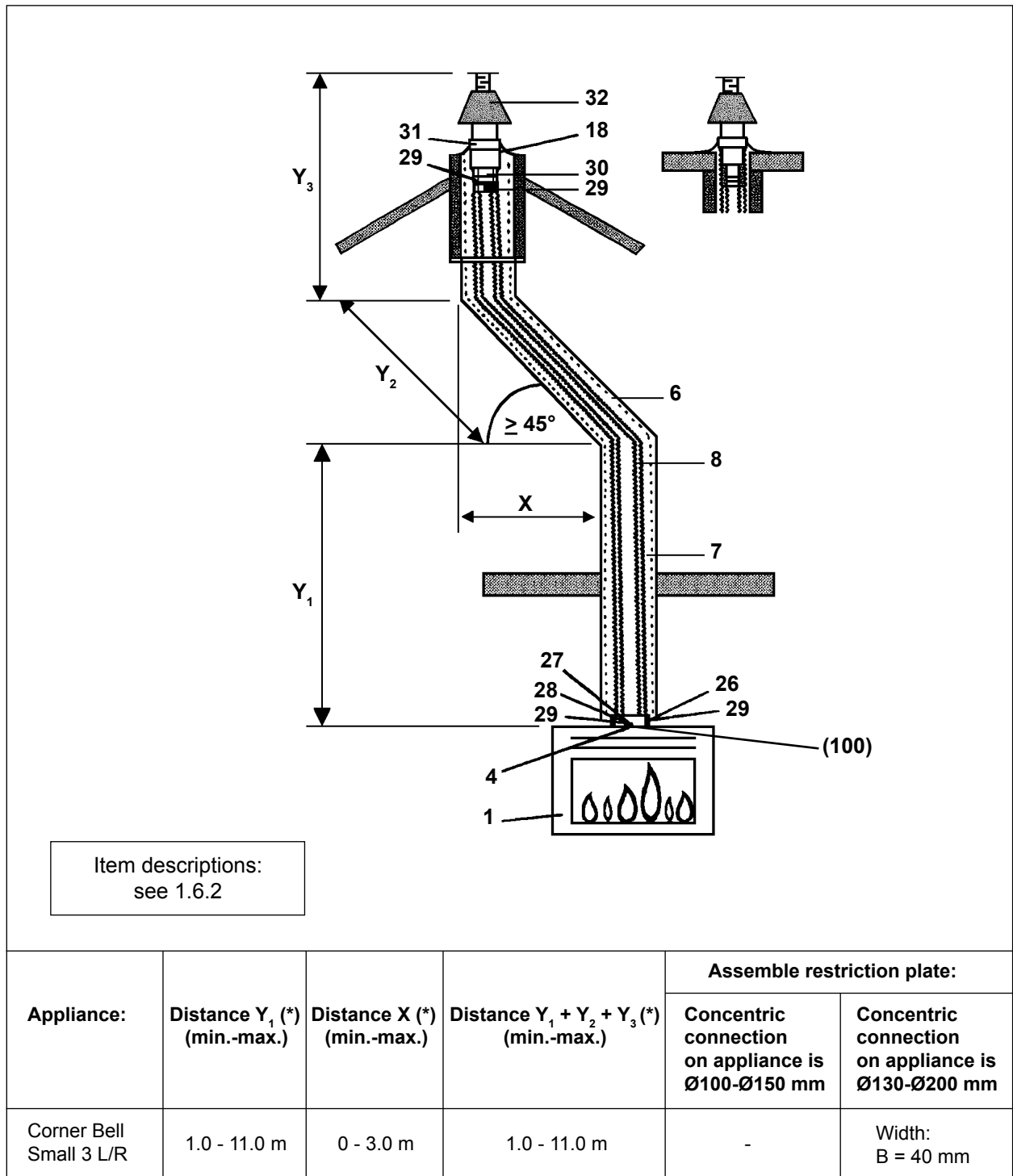
ALL SIZES INCLUDE THE LENGTH OF THE ROOF OR WALL TERMINATION



Appliance:	Distance Y (min.-max.)	Assemble restriction plate:	
		Concentric connection on appliance is Ø100-Ø150 mm	Concentric connection on appliance is Ø130-Ø200 mm
Corner Bell Small 3 L/R	2.0 - 4.0 m	Width: B = 30 mm	Width: B = 65 mm
	4.0 - 12.0 m	Width: B = 40 mm	Width: B = 80 mm

**Figure 8: Vertical chimney outlet using an existing unsound lined chimney or when no chimney liners are present (Flexible Ø100 mm / Ø150 mm)**

ALL SIZES INCLUDE THE LENGTH OF THE ROOF OR WALL TERMINATION



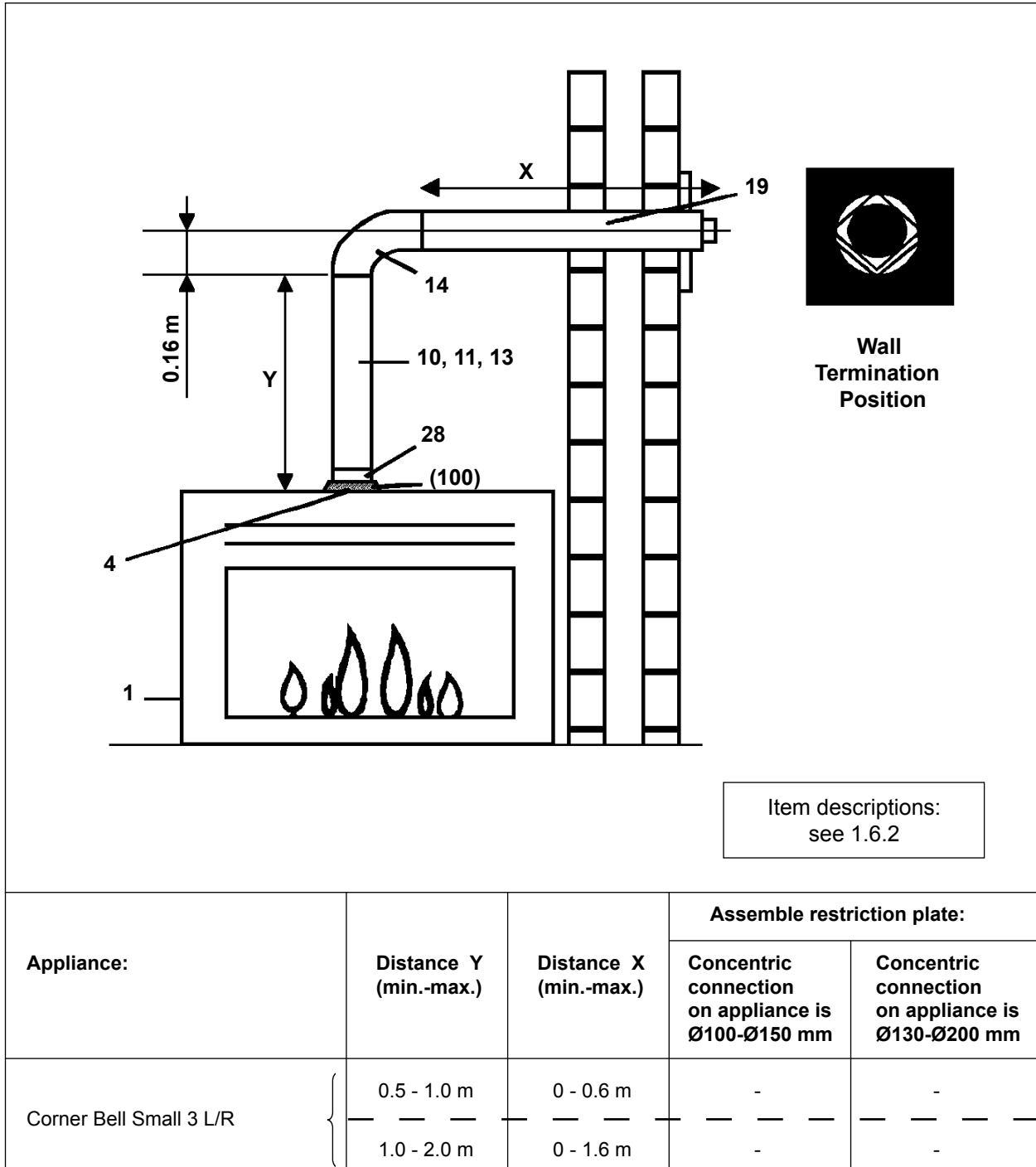
(\*) :  $(Y_1 + Y_2 + Y_3) : X \geq 2 : 1$   
 (Vertical to horizontal ratio (or  $45^\circ$  upwards) is always at least 2 to 1)

**Figure 9: Vertical chimney outlet using an existing unsound lined chimney or when the chimney is unlined; with a bend  $\geq 45^\circ$  (Flexible  $\text{Ø}100$  mm /  $\text{Ø}150$  mm)**

ALL SIZES INCLUDE THE LENGTH OF THE ROOF OR WALL TERMINATION

**RIGID CONCENTRIC FLUE Ø100 mm - Ø150 mm SYSTEM CONNECTION**  
**POSSIBILITIES and with wall outlet Ø100 mm - Ø150 mm**

**Appliance: Concentric flue connection Ø100-Ø150 mm or Ø130-Ø200 mm**

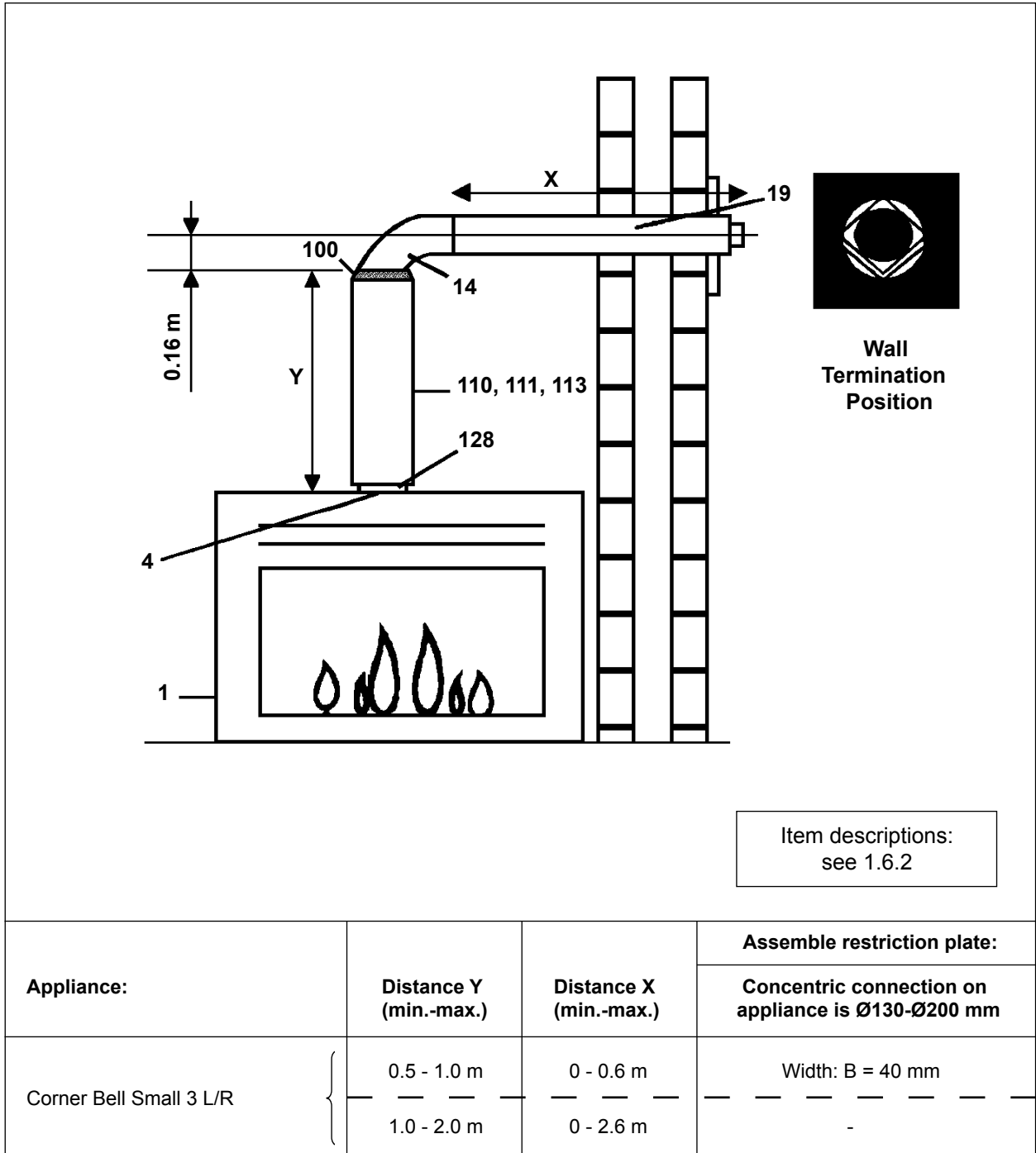


**Figure 10: Horizontal wall termination**

ALL SIZES INCLUDE THE LENGTH OF THE ROOF OR WALL TERMINATION

**RIGID CONCENTRIC FLUE Ø130 mm - Ø200 mm SYSTEM CONNECTION**  
**POSSIBILITIES and with wall outlet Ø100 mm - Ø150 mm**

**Appliance: Concentric flue connection Ø130-Ø200 mm**

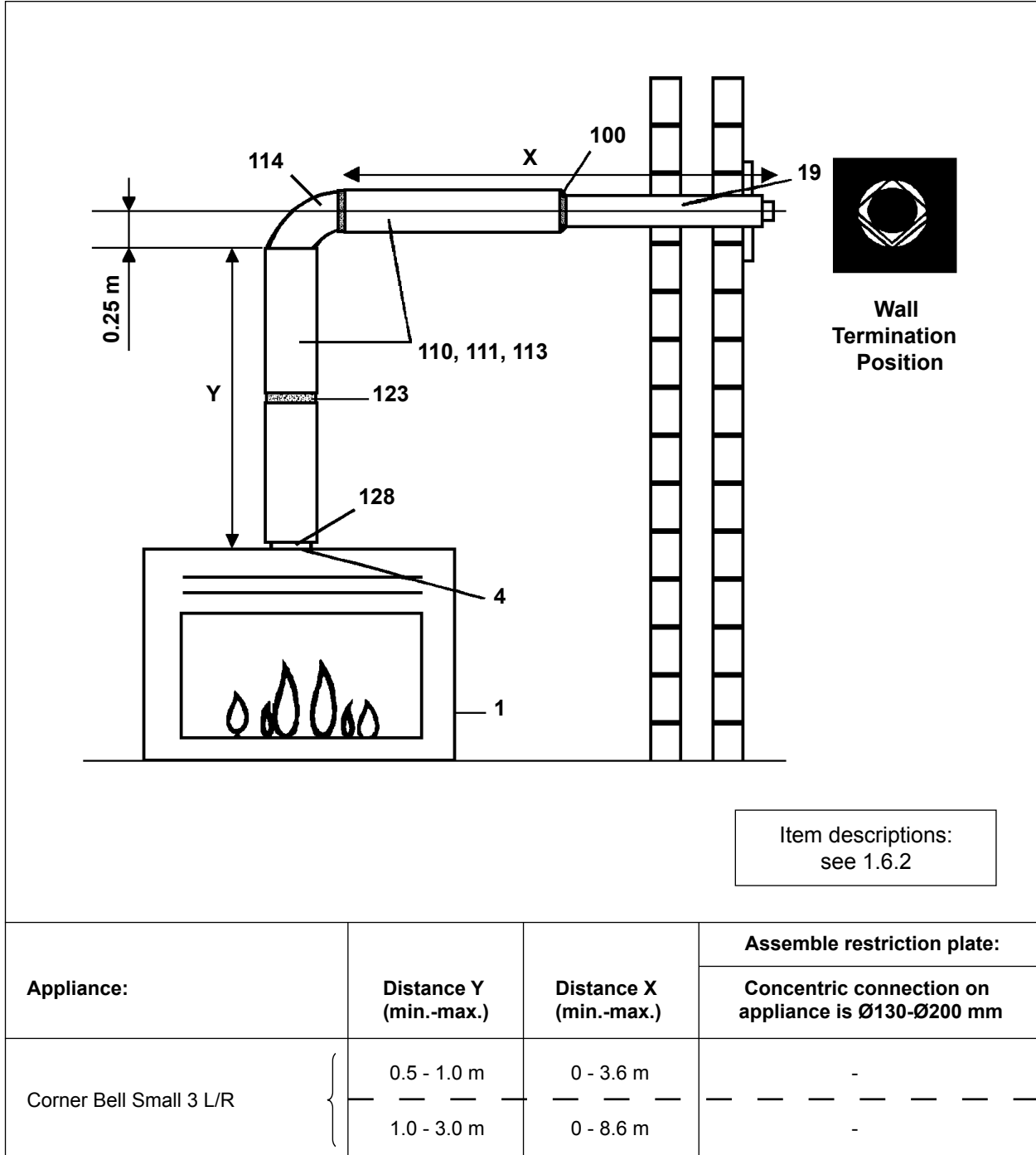


**Figure 11: Horizontal wall termination**

ALL SIZES INCLUDE THE LENGTH OF THE ROOF OR WALL TERMINATION

**RIGID CONCENTRIC FLUE Ø130 mm - Ø200 mm SYSTEM CONNECTION**  
**POSSIBILITIES and with wall outlet Ø100 mm - Ø150 mm**

**Appliance: Concentric flue connection Ø130-Ø200 mm**

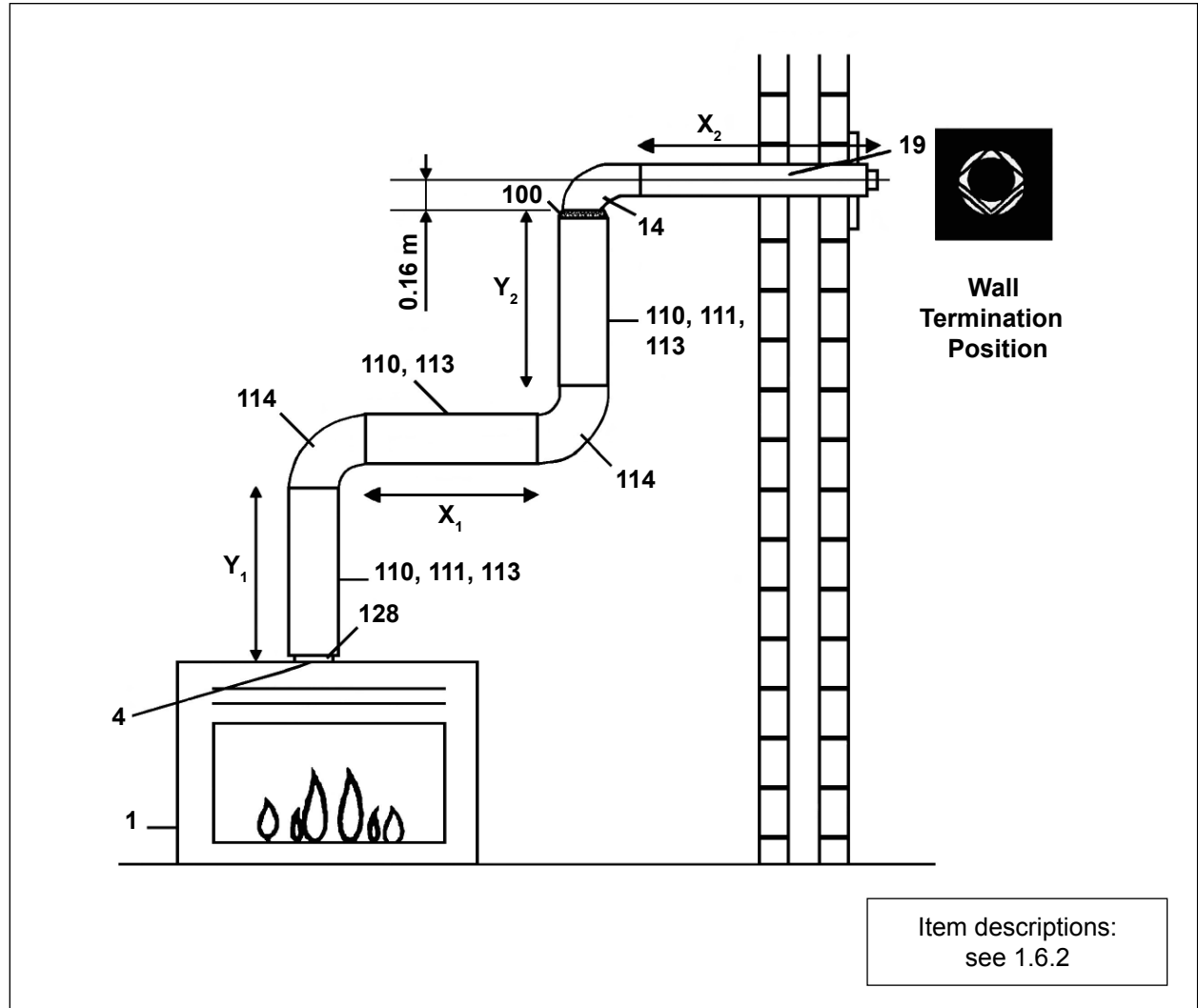


**Figure 12: Horizontal wall termination**

ALL SIZES INCLUDE THE LENGTH OF THE ROOF OR WALL TERMINATION

**RIGID CONCENTRIC FLUE Ø130 mm - Ø200 mm SYSTEM CONNECTION**  
**POSSIBILITIES and with wall outlet Ø100 mm - Ø150 mm**

**Appliance: Concentric flue connection Ø130-Ø200 mm**



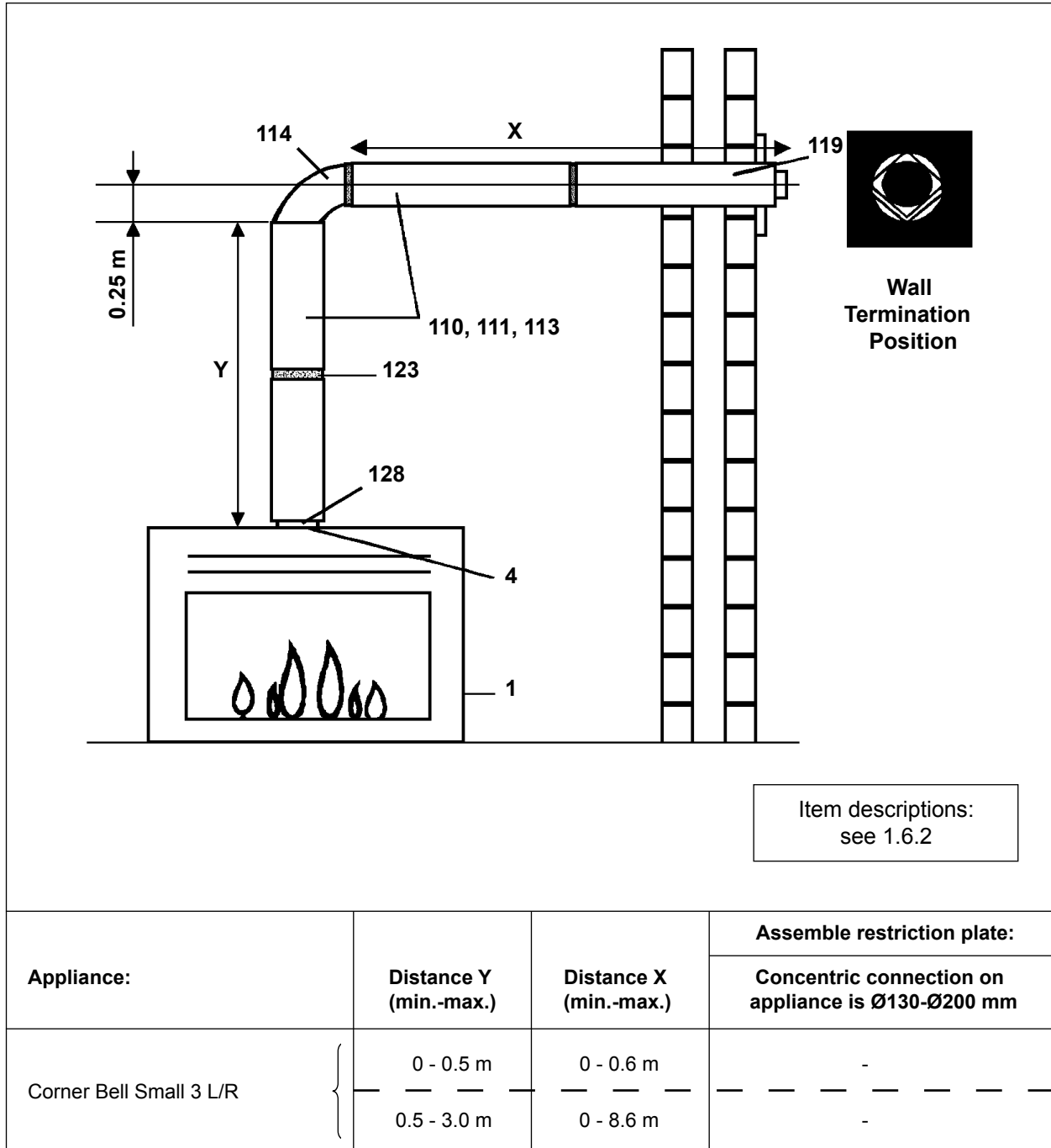
Appliance:	Distance Y <sub>1</sub> (min.-max.)	Distance X <sub>1</sub> (min.-max.)	Distance Y <sub>2</sub> (min.-max.)	Distance X <sub>2</sub> (min.-max.)	Assemble restriction plate:
					Concentric connection on appliance is Ø130-Ø200 mm
Corner Bell Small 3 L/R	0 - 0.5 m	0 - 0.5 m	0.5 - 1.0 m	0 - 0.6 m	-
	0.5 - 1.0 m	0 - 0.5 m	0 - 0.5 m	0 - 0.6 m	-
	1.0 - 3.0 m	0 - 1.0 m	0.5 - 2.0 m	0 - 0.6 m	-
	1.0 - 3.0 m	0 - 3.0 m	1.0 - 3.0 m	0 - 0.6 m	-

**Figure 13: Horizontal wall termination**

ALL SIZES INCLUDE THE LENGTH OF THE ROOF OR WALL TERMINATION

**RIGID CONCENTRIC FLUE Ø130 mm - Ø200 mm SYSTEM CONNECTION**  
**POSSIBILITIES and with wall outlet Ø130 mm - Ø200 mm**

**Appliance: Concentric flue connection Ø130-Ø200 mm**



**Figure 14: Horizontal wall termination**

ALL SIZES INCLUDE THE LENGTH OF THE ROOF OR WALL TERMINATION



## 1.6.2 Item descriptions for figures 4 t/m 14

FIG. NO.	DESCRIPTION
1	Gas fire; Concentric flue connection Ø130/Ø200 mm or Ø100/Ø150 mm
2	-
3	-
4	Restriction plate (The different sizes restriction plates are supplied with every appliance)
5	Chimney, min. Ø150 mm internal, totally gas tight.
6	Chimney or fireproof sleeving. Min. Ø160 mm internal.
7	Ø100 mm internal flexible stainless steel gas vent chimney liner AISI 316TI.
8	Ø150 mm internal flexible stainless steel gas vent chimney liner AISI 316TI.
9	-

**AVAILABLE COMPONENTS FOR THE BELLFIRES (M&G) CONCENTRIC FLUE SYSTEM Ø100 mm - Ø150 mm**






FIG. NO.	BELLFIRES ART. / ORDER NO.	DESCRIPTION		Color(*)		Application	
				RVS	antr.	RIGID	FLEX
10	302289	Twin-wall balanced flue pipe, L = 500 mm, incl. ① and ②		•		•	
11	302290	Twin-wall balanced flue pipe, L = 1000 mm, incl. ① and ②		•		•	
12	302291	Telescopic twin-wall balanced flue pipe, L = min. 325 / max. 440 mm, incl. ① and ②		•		•	
13	302292	Adjustable length twin-wall balanced flue pipe, L = 500 mm, incl. ① and ②		•		•	
14	302297	Twin-wall balanced flue elbow 90°, incl. ① and ②		•		•	








FIG. NO.	BELLFIRES ART. / ORDER NO.	DESCRIPTION		Color(*)		Application	
				RVS	antr.	RIGID	FLEX
15	302298	Twin-wall balanced flue elbow 45°, incl. ① and ②		●		●	
16	302295	Vertical (roof) termination kit, L = 1360 mm (vertical), incl. ①, ② and ④		●	●	●	●
17	302212	Adjustable roof flashing. Roof pitch 20° - 45° (**), with lead flashing		●		●	●
18	302213	Roof flashing for existing chimney or flat roof		●		●	●
19	302296	Horizontal (wall) termination kit, L = 600 mm (horizontally adjustable), incl. ①, ② and one set of wall spacer plates		●	●	●	●
20	302293	① : Stainless steel locking band Ø150 mm, quick-fastening		●		●	●
21	302210	② : Silicone seal Ø150 mm				●	●
23	302215	④ : Wall strap		●		●	●
24	302214	Set of ceiling finishing plates / Fire stops		●		●	●


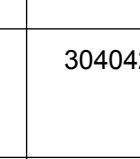
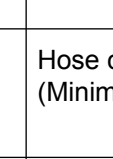
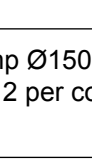
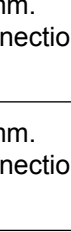



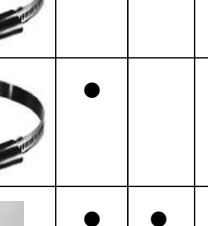
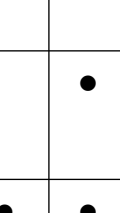


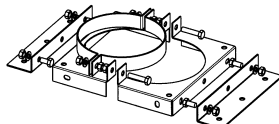
FIG. NO.	BELLFIRES ART. / ORDER NO.	DESCRIPTION		Color(*)		Application	
				RVS	antr.	RIGID	FLEX
25	302189	Ceiling plate for transition Ø100 mm / Ø150 mm rigid - Ø100 mm (flex.).		•		•	•
26	302278	Stainless steel adapter piece (100) from fire to flexible, Ø100 mm external (rigid) x Ø107 mm internal (flex.). [appliance - Ø100 mm flex.] and [Ø100 mm rigid - Ø100 mm flex.].		•			•
27	302279	Stainless steel adapter piece (150) fire to flexible, Ø148 mm external (rigid) x Ø148 mm internal (flex.) [appliance - Ø150 mm flex.].		•			•
28	302217	Stainless steel locking band Ø150 mm. For adapter 150 [appliance - Ø150 mm (flex.)], Screw-fastening		•		•	•
29	303776	Stainless steel screws Ø3.5 mm x 9.5 mm. For securing the flexible concentric flue. (Minimum 3 screws per connection)		•			•
30	304041	Hose clamp Ø100 mm. (Minimum 2 per connection)		•			•
31	304042	Hose clamp Ø150 mm. (Minimum 2 per connection)		•			•
32	302307	Vertical (roof) termination kit, L = 610 mm (vertical), incl. ① and ②. For the flexible flue system.		•	•	•	•
33	302301	Concentric T-piece with gauging orifice, incl. ① and ②		•		•	

FIG. NO.	BELLFIRES ART. / ORDER NO.	DESCRIPTION		Color(*)		Application	
				RVS	antr.	RIGID	FLEX
34	302302	Concentric pipe with gauging orifice, L = 165 mm, incl. ① and ②		●		●	
35	302303	90° concentric bend with inspection panel, incl. ① and ②		●		●	
36	321948	Universal wall / floor support Ø150 mm		●		●	

(\*) : Color : RVS : Stainless steel self-colour, polished  
 antr. : Anthracite colour lacquer, matt

(\*\*) : Adjustable roof flashing for a slope > 45° can be supplied on request.

When installing a balanced-flue “closed” gas fire in an existing chimney, ensure stainless steel flexible liners (Ø100 mm or Ø130 mm) conforming with BS 316 are used to conduct the spent gases.

**AVAILABLE COMPONENTS FOR THE BELLFIRES (M&G) CONCENTRIC  
FLUE SYSTEM Ø130 mm - Ø200 mm**















FIG NO.	BELLFIRES ART. / ORDER NO.	DESCRIPTION		Color(*)		Application	
				RVS	antr.	RIGID	FLEX
100	302319	Concentric reduction of Ø130 / Ø200 mm → Ø100 / Ø150 mm		•		•	•
110	302308	Twin-wall balanced flue pipe, L= 500 mm, incl. ⑤ and ⑥		•		•	
111	302309	Twin-wall balanced flue pipe, L= 1000 mm, incl. ⑤ and ⑥		•		•	
113	302310	Adjustable length twin-wall balanced flue pipe, L= 500 mm, incl. ⑤ and ⑥		•		•	
114	302314	Twin-wall balanced flue elbow 90°, incl. ⑤ and ⑥		•		•	
115	302315	Twin-wall balanced flue elbow 45°, incl. ⑤ and ⑥		•		•	
119	302313	Horizontal (wall) termination kit, L= 600 mm (horizontally adjustable), incl. ⑤, ⑥ and one set of wall spacer plates		•	•	•	

FIG. NO.	BELLFIRES ART. / ORDER NO.	DESCRIPTION		Color(*)		Application	
				RVS	antr.	RIGID	FLEX
120	302311	⑤ : Stainless steel locking band Ø200 mm, quick-fastening		•		•	•
121	302248	⑥ : Silicone seal Ø200 mm				•	•
123	302251	⑧ : Wall strap				•	•
124	302250	Set of ceiling finishing plates / Fire stops		•		•	•
126	302281	Stainless steel adapter piece (130) from fire to flexible, Ø130 mm external (rigid) x Ø137 mm internal (flex.), [appliance - Ø130 mm flex.] and [Ø130 mm rigid - Ø130 mm flex.]		•			•
127	302282	Stainless steel adapter piece (200) from fire to flexible, Ø198 mm external (rigid) x Ø198 mm internal (flex.), [appliance - Ø200 mm flex.]		•			•
128	302257	Stainless steel locking band Ø200 mm. For adapter 200. [appliance - Ø200 mm flex.]. Screw-fastening		•		•	•
129	303776	Stainless steel screws Ø3.5 mm x 9.5 mm. For securing the flexible concentric flue. (Minimum 3 screws per connection)		•			•
130	304045	Hose clamp Ø130 mm. (Minimum 2 per connection)		•			•
131	304046	Hose clamp Ø200 mm. (Minimum 2 per connection)		•			•

**AVAILABLE COMPONENTS FOR THE POUJOLAT PGI CONCENTRIC  
FLUE SYSTEM Ø100 mm - Ø150 mm**







FIG. NO.	POUJOLAT ART. / ORDER NO.	DESCRIPTION	
	37100403	Twin-wall balanced flue pipe, L = 250 mm	
10	37100404	Twin-wall balanced flue pipe, L = 450 mm	
11	37100405	Twin-wall balanced flue pipe, L = 950 mm	
12	37100429	Telescopic twin-wall balanced flue pipe, L = min. 390 mm / max. 640 mm	
14	37100441	Twin-wall balanced flue elbow 90°	
15	37100421	Twin-wall balanced flue elbow 45°	








FIG. NO.	POUJOLAT ART. / ORDER NO.	DESCRIPTION	
	37100411	Twin-wall balanced flue elbow 30°	
	37100401	Twin-wall balanced flue elbow 15°	
16	37100654	Vertical (roof) termination kit, L = 140 mm	
17	45150171	Roof flashing, suitable for a brick roof, with a roof pitch of 15° - 30°	
	45150170	Roof flashing, suitable for a tiled roof, with a roof pitch of 15° - 30°	
	45150172	Roof flashing, suitable for a brick roof, with a roof pitch of 30° - 45°	
	45150173	Roof flashing, suitable for a tiled roof, with a roof pitch of 30° - 45°	






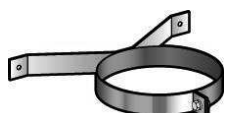
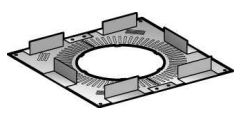
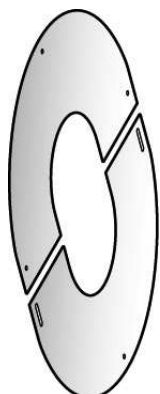
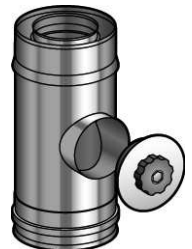
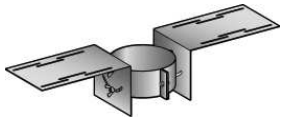
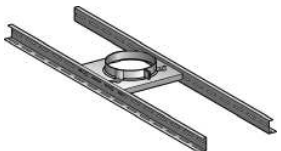



FIG. NO.	POUJOLAT ART. / ORDER NO.	DESCRIPTION	
18	45150169	Roof flashing for existing chimney or flat roof	
19	37100610	Horizontal (wall) termination kit, L = min. 365 mm / max. 585 mm	
20	45150076	Stainless steel locking band Ø150 mm, quick-fastening	
23	45150072	Wall strap, Ø150 mm	
24	37100442	Ceiling/wall plate with spacers and ventilation grooves	
	37100425	Set of ceiling finishing plates / Fire stops, suitable for a roof pitch of 0° - 10°	
	37100426	Set of ceiling finishing plates / Fire stops, suitable for a roof pitch of 10° - 30°	
	37100427	Set of ceiling finishing plates / Fire stops, suitable for a roof pitch of 30° - 40°	
	37100428	Set of ceiling finishing plates / Fire stops, suitable for a roof pitch of 40° - 50°	
34	37100407	Concentric pipe with inspection opening, L = 250 mm	

FIG. NO.	POUJOLAT ART. / ORDER NO.	DESCRIPTION	
36	45150165	Roof support, (universal) Ø150 mm	
36	45150081	Floor support, (universal) Ø150 mm	
37	37100611	Adapter: Bellfires Ø100-150 mm → Pougoulat PGI Ø100-150 mm (Appliance 100/150 → Pougoulat PGI 100/150)	
100	37100614	Adapter: Bellfires Ø130-200 mm → Pougoulat PGI Ø100-150 mm (Appliance 130/200 → Pougoulat PGI 100/150)	
101	37100613	Concentric reduction of Pougoulat PGI Ø130-200 mm → Pougoulat PGI Ø100-150 mm	

**AVAILABLE COMPONENTS FOR THE POUJOLAT PGI CONCENTRIC  
FLUE SYSTEM Ø130 mm - Ø200 mm**







FIG. NO.	POUJOLAT ART. / ORDER NO.	DESCRIPTION	
	37130403	Twin-wall balanced flue pipe, L = 250 mm	
110	37130404	Twin-wall balanced flue pipe, L = 450 mm	
111	37130405	Twin-wall balanced flue pipe, L = 950 mm	
112	37130429	Telescopic twin-wall balanced flue pipe, L = min. 390 mm / max. 640 mm	
114	37130441	Twin-wall balanced flue elbow 90°	
115	37130421	Twin-wall balanced flue elbow 45°	





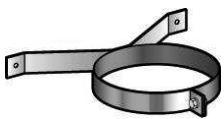
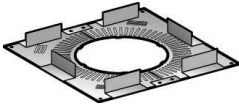
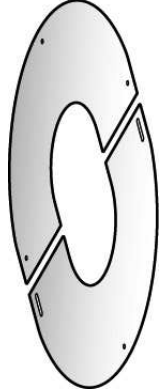
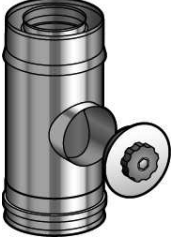
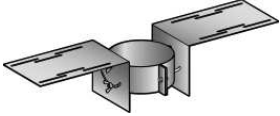
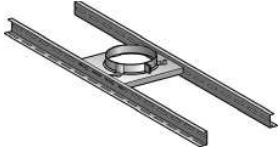

FIG. NOR.	POUJOLAT ART. / ORDER NO.	DESCRIPTION	
	37130411	Twin-wall balanced flue elbow 30°	
115	37130401	Twin-wall balanced flue elbow 15°	
119	37130610	Horizontal (wall) termination kit, L = min. 425 mm / max. 585 mm	
120	45200076	Stainless steel locking band Ø200 mm, quick-fastening	
123	45200072	Wall strap, Ø200 mm	
124	37130442	Ceiling/wall plate with spacers and ventilation grooves	
	37130425	Set of ceiling finishing plates / Fire stops, suitable for a roof pitch of 0°- 10°	
	37130426	Set of ceiling finishing plates / Fire stops, suitable for a roof pitch of 10°- 30°	
	37130427	Set of ceiling finishing plates / Fire stops, suitable for a roof pitch of 30°- 40°	
	37130428	Set of ceiling finishing plates / Fire stops, suitable for a roof pitch of 40°- 50°	

FIG. NO.	POUJOLAT ART. / ORDER NO.	DESCRIPTION	
	37130407	Concentric pipe with inspection opening, L = 250 mm	
	45200165	Roof support, (universal) Ø200 mm	
	45200081	Floor support, (universal) Ø200 mm	
	37130615	Adapter: Bellfires Ø130-200 mm → Pujoulat PGI Ø130-200 mm (Appliance 130/200 → Pujoulat PGI 130/200)	

**AVAILABLE COMPONENTS FOR THE ONTOP METALOTERM US CONCENTRIC FLUE SYSTEM Ø100 mm - Ø150 mm**



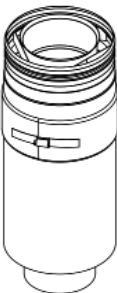
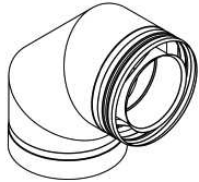


FIG. NO.	ONTOP ART. / ORDER NO.	DESCRIPTION	
	USA 10	Adapter for Bellfires appliances with Ø100-Ø150 mm concentric connection	
	US 25 10	Twin-wall balanced flue pipe, L = 250 mm	
10	US 50 10	Twin-wall balanced flue pipe, L = 500 mm	
11	US 100 10	Twin-wall balanced flue pipe, L = 1000 mm	
12	USPP 10	Telescopic twin-wall balanced flue pipe, L = min. 60 / max. 250 mm	
14	USB 90 10	Twin-wall balanced flue elbow 90°	
15	USB 45 10	Twin-wall balanced flue elbow 45°	
	USB 30 10	Twin-wall balanced flue elbow 30°	


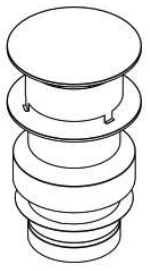
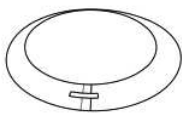
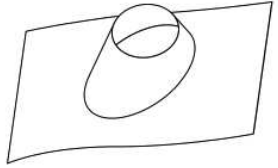
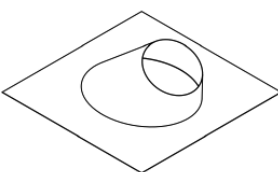
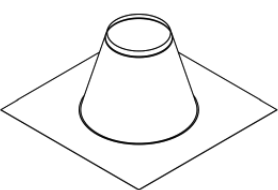
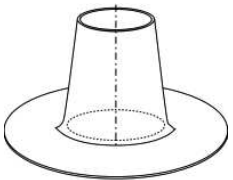
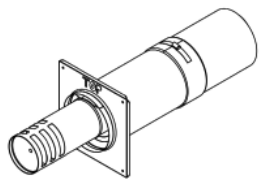
FIG. NO.	ONTOP ART. / ORDER NO.	DESCRIPTION	
	USB 15 10	Twin-wall balanced flue elbow 15°	
16	USDVC2 10	Vertical (roof) termination kit, L = 375 mm, incl. ①	
16	USSR 10	Storm collar Ø150 mm	
17	USLS 10	Adjustable roof flashing. Roof pitch 20° - 45° (**), with lead flashing	
17	USDH 10	Roof flashing plate for roof pitch 5° - 30°	
18	USDP 10	Roof flashing for existing chimney or flat roof	
18	USDPAL 10	Roof flashing - Aluminium for existing chimney or flat roof	
19	USDHC5 10	Horizontal (wall) termination kit, L = 475 mm (horizontally adjustable), incl. ②	


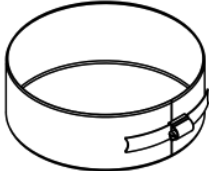
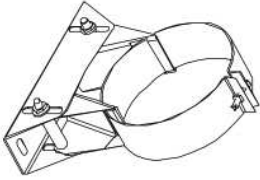
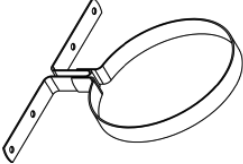
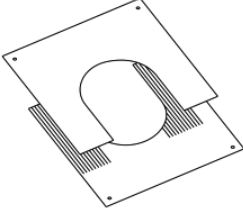
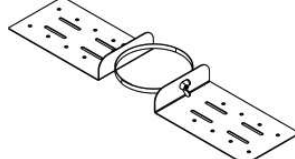
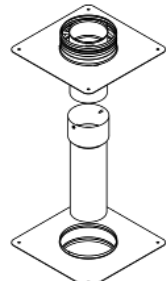
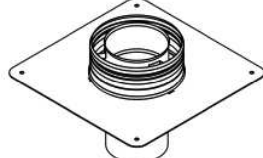
FIG. NO.	ONTOP ART. / ORDER NO.	DESCRIPTION	
20	USKB 10	① : Locking band, quick-fastening	
21	USAB 10	② : Cover band, screw-fastening	
23	USMB 10	Wall strap, adjustable	
23	USEB 10	Fitting bracket	
24	USCP 10	Set of ceiling finishing plates / Fire stops / Centring plates	
24	USDQ 10	Roof support	
25	USSAN 10	Renovation set	
25	USSAN1 10	Top of renovation set	



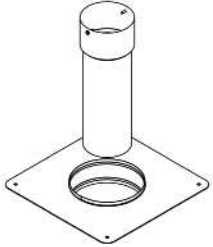
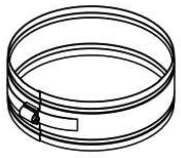
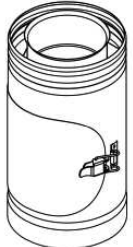

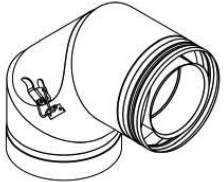
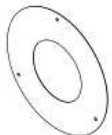
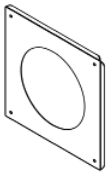
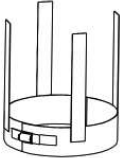

FIG. NO.	ONTOP ART. / ORDER NO.	DESCRIPTION	
25	USSAN2 10	Bottom renovation set	
28	USKBS 10	Locking band, screw-fastening	
	USI 10	Concentric pipe with inspection panel, L = 250 mm	
34	USEM 10	Concentric pipe with gauging orifice, L = 150 mm	
35	USBI 10	90° concentric bend with inspection panel	
	USR 10	Rosette smooth Ø150 mm	
	USMPG 10	Wall plate large Ø150 mm, ∅300 mm	
	ASAH 10	Spacer bracket	

FIG. NO.	ONTOP ART. / ORDER NO.	DESCRIPTION	
	USVG 10 13	Concentric reduction of $\text{Ø}100\text{-}\text{Ø}150\text{ mm} \rightarrow \text{Ø}130\text{-}\text{Ø}200\text{ mm}$	

### AVAILABLE COMPONENTS FOR THE ONTOP METALOTERM US CONCENTRIC FLUE SYSTEM $\text{Ø}130\text{ mm} - \text{Ø}200\text{ mm}$



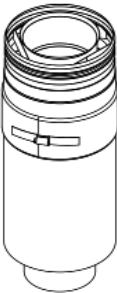
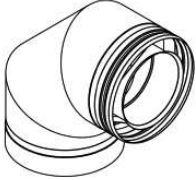
FIG. NO.	ONTOP ART. / ORDER NO.	DESCRIPTION	
	USA 13	Adapter for Bellfires appliances with $\text{Ø}130\text{-}\text{Ø}200\text{ mm}$ concentric connection	
	US 25 13	Twin-wall balanced flue pipe, L = 250 mm	
10	US 50 13	Twin-wall balanced flue pipe, L = 500 mm	
11	US 100 13	Twin-wall balanced flue pipe, L = 1000 mm	
12	USPP 13	Telescopic twin-wall balanced flue pipe, L = min. 60 / max. 250 mm	
14	USB 90 13	Twin-wall balanced flue elbow $90^\circ$	

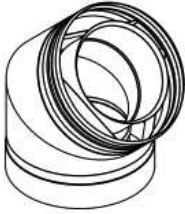


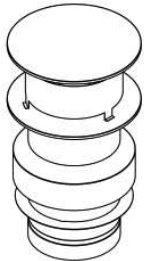
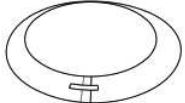
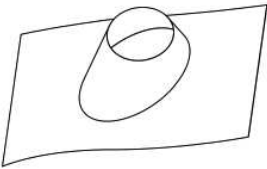
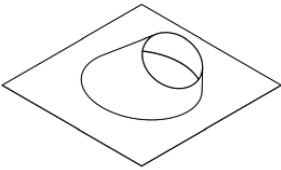
FIG. NO.	ONTOP ART. / ORDER NO.	DESCRIPTION	
15	USB 45 13	Twin-wall balanced flue elbow 45°	
	USB 30 13	Twin-wall balanced flue elbow 30°	
	USB 15 13	Twin-wall balanced flue elbow 15°	
16	USDVC2 13	Vertical (roof) termination kit, L = 375 mm, incl. ①	
16	USSR 13	Storm collar Ø150 mm	
17	USLS 13	Adjustable roof flashing. Roof pitch 20° - 45° (**), with lead flashing	
17	USDH 13	Roof flashing plate for roof pitch 5° - 30°	

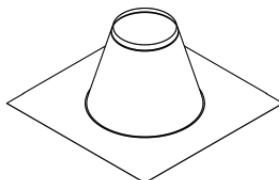
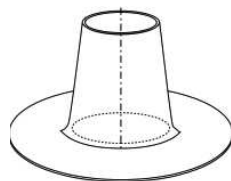
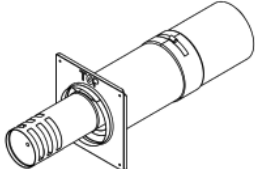

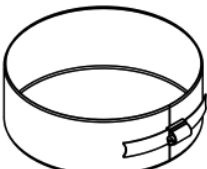
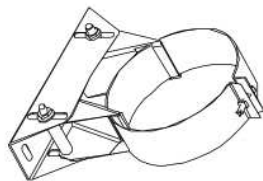
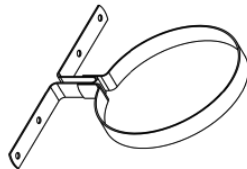
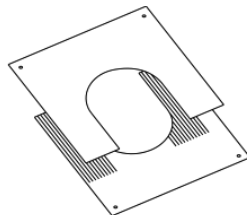
FIG. NO.	ONTOP ART. / ORDER NO.	DESCRIPTION	
18	USDP 13	Roof flashing for existing chimney or flat roof	
18	USDPAL 13	Roof flashing - Aluminium for existing chimney or flat roof	
19	USDHC4 13	Horizontal (wall) termination kit, L = 475 mm (horizontally adjustable), incl. ②	
20	USKB 13	① : Locking band, quick-fastening	
21	USAB 13	② : Cover band, screw-fastening	
23	USMB 13	Wall strap, adjustable	
23	USEB 13	Fitting bracket	
24	USCP 13	Set of ceiling finishing plates / Fire stops / Centring plates	

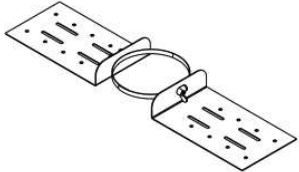
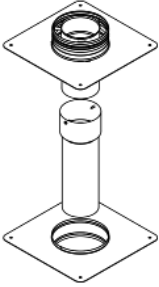
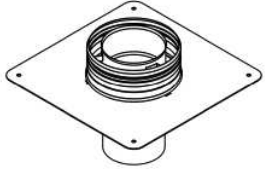
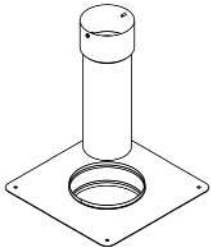
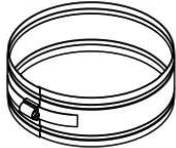


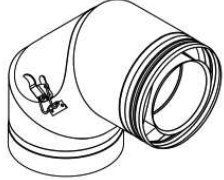

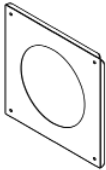
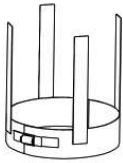

FIG. NO.	ONTOP ART. / ORDER NO.	DESCRIPTION	
24	USDQ 13	Roof support	
25	USSAN 13	Renovation set	
25	USSAN1 13	Top of renovation set	
25	USSAN2 13	Bottom renovation set	
28	USKBS 13	Locking band, screw-fastening	
	USI 13	Concentric pipe with inspection panel, L = 250 mm	
34	USEM 13	Concentric pipe with gauging orifice, L = 150 mm	

FIG. NO.	ONTOP ART. / ORDER NO.	DESCRIPTION	
35	USBI 13	90° concentric bend with inspection panel	
	USR 13	Rosette smooth Ø200 mm	
	USMPG 13	Wall plate large Ø200 mm, ▧ 350 mm	
	ASAH 13	Spacer bracket	
	USVG 13 10	Concentric reduction of Ø130-Ø200 mm → Ø100-Ø150 mm	



- The room-sealed gas appliances have been approved in combination with the components of the concentric flue systems listed in this instruction book, according to the European CE norm for gas appliances and may therefore be used **only** with these components.
- The components of the concentric flue system of Bellfires (M&G system), Poujoulat (PGI system) and Ontop (Metaloterm US system) may **not** be used together in one installation.
- Check whether the wall or roof termination kit to be used **exactly** matches one of those listed in this instruction book.

### 1.6.3 Gas connection

Operation (gas regulator block (and receiver)) **outside** the appliance (in the operating unit):

The gas connection is situated where the operating unit is built in near to the appliance.

Use only gas piping with a minimum diameter of 1/2" and a shut-off valve.

### 1.6.4 Operating unit

If the appliance is fitted with an operating unit comprising gas control block and receiver, this will be located, once it has been built in, at a **maximum of 50 cm** from the left or right hand side of the appliance.

### 1.6.5 Convection package connections

When fitting a convection package (= convection casing and convection set (1x or 2x)), consideration should be given to the openings at approximately 1 meter above the appliance for the warm air exiting grids.

## 1.7 POSITIONING THE APPLIANCE

**Important:** The fireplace is constructed on a sufficiently solid floor that can bear the weight of the appliance.

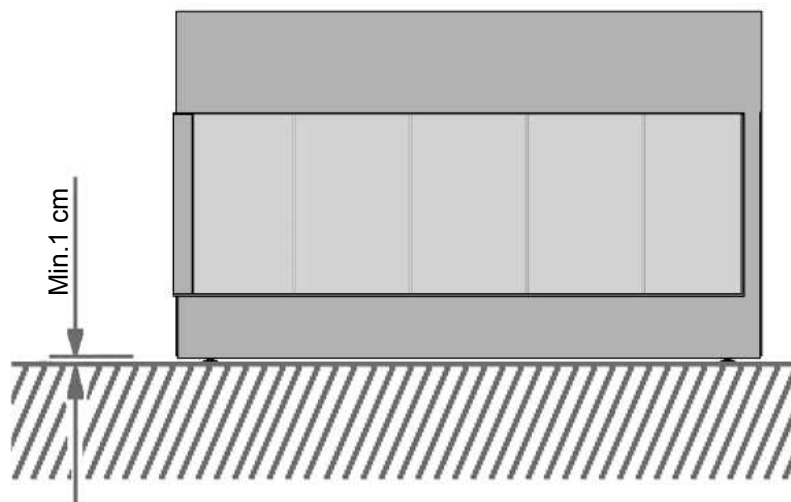


Ensure a free space of at least 1 cm between the bottom of the appliance and the floor.

Ensure that the temperature of the floor under and in front of the appliance can never rise above 85°C!

Make use of a temperature protection plate (of nonflammable material) on the floor if necessary.

Take care with a floor made of a flammable material.



**Figure 15:** A clearance of at least 1 cm must be maintained between the bottom of the appliance and the floor.

Never position the appliance directly against the rear wall, but always place a nonflammable insulation plate, at least 12 mm thick, between the appliance and the rear wall, with free space on either side of 2 cm. (Total  $\pm$  5 cm.)  
The rear wall must be made of nonflammable material.

Never use combustible materials during the installation.

Ventilate the fireplace, by allowing vents above and below the fireplace.

During installation of the gas fire, a clearance of 3 mm should be maintained on all sides of the appliance to allow for expansion of the appliance during operation.

Do not insulate the appliance! Only the top and sides may be fitted with a strip of white, loose insulation wool (heat-resistant to 1000°C), width 15 cm max. to protect the wall.

Do not use fibreglass or Rockwool, or any other sort of insulating material. These emit a pungent odour. This is considered extremely unpleasant. They may also cause discolouring of the column.

Flammable materials, such as curtains, should not be placed in the vicinity of the gas fire.  
Minimum safe distance: 100 cm.

If desired, fit a convection package to the appliance.  
(See chapter 1.1)



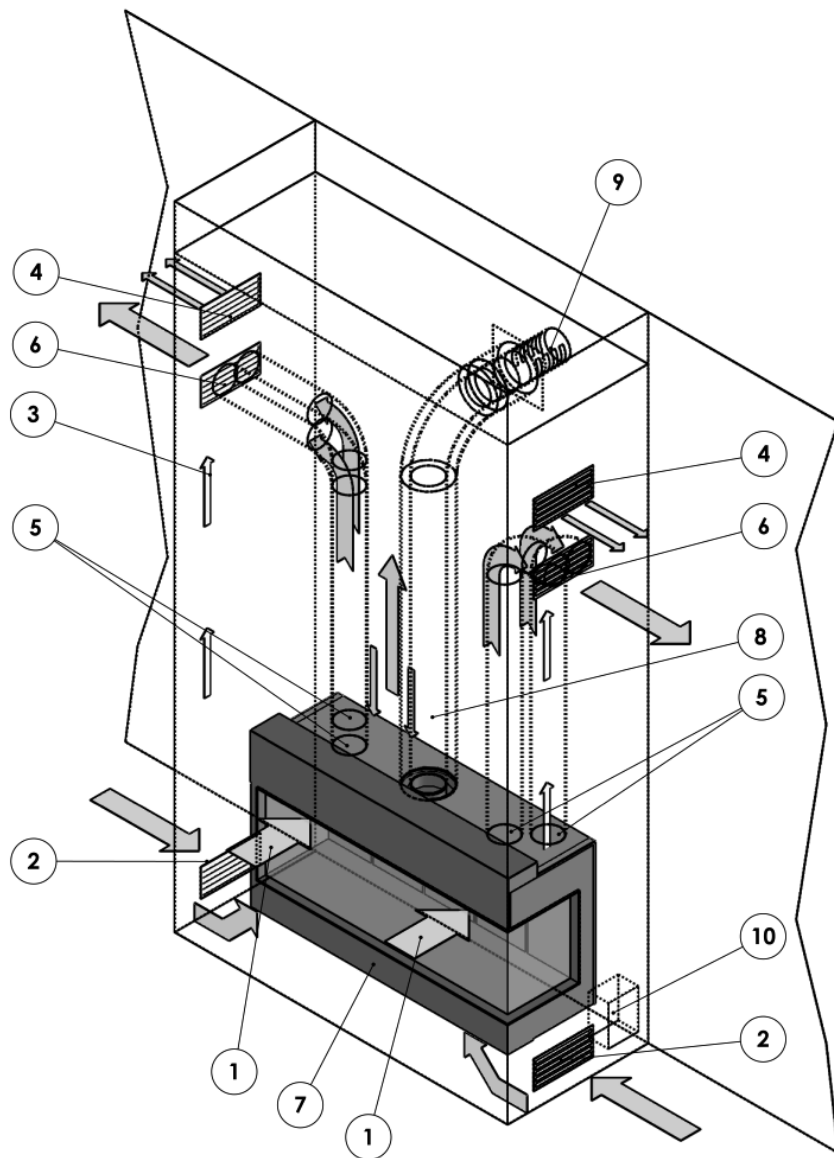
The appliance can be easily installed using a set of carrying brackets (accessory). After installing: remove carrying brackets!



Corner Bell Small 3 R with options:

- 10 cm frame (4 sided) and mantle iron
- convection package



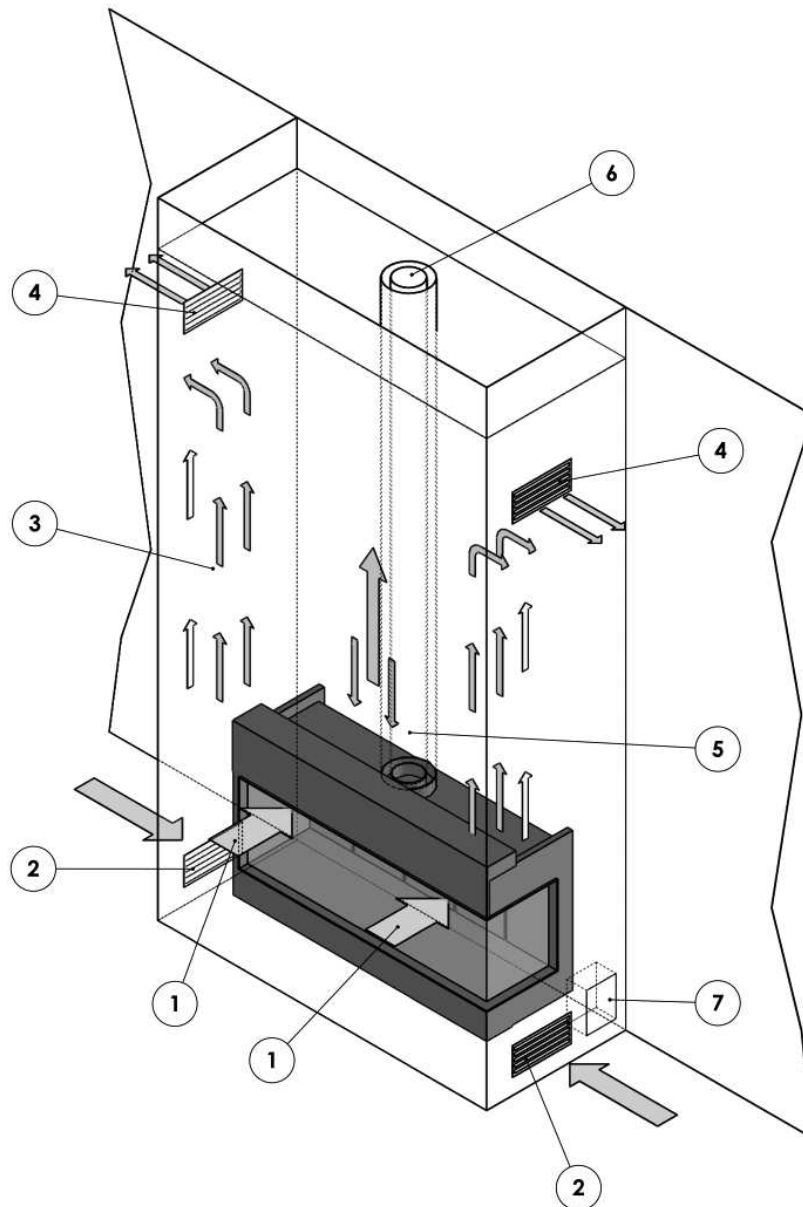


**Figure 16:** **Appliance installed in ventilated chimney breast**  
**Horizontal outlet of the flue gas exhaust / combustion air**  
**supply via the wall.**

**Fitted with the options / accessories:**

- **convection package (= convection casing and 1x convection set)**
- **1x extra convection set**

- 1 Inlet opening (appliance) convection air
- 2 Inlet opening (grate) (chimney breast) convection air
- 3 Natural convection in the chimney breast
- 4 Outlet opening (grate) (chimney breast) natural convection air
- 5 Outlet opening (appliance) convection air / connection convection set (2x or 4x)
- 6 Outlet opening (grill convection set) (chimney breast) convection air (2x or 4x)
- 7 -
- 8 Concentric flue connection appliance; Ø130-200 mm for a horizontal wall outlet
- 9 Horizontal wall outlet
- 10 Built in operating unit with gas regulator block and receiver



**Figure 17: Appliance installed in ventilated chimney breast  
Vertical outlet of the flue gas exhaust / combustion air  
supply via the roof.  
Fitted without convection package**

- 1 Inlet opening (appliance) convection air
- 2 Inlet opening (grate) (chimney breast) convection air
- 3 Natural convection in the chimney breast
- 4 Outlet opening (grate) (chimney breast) convection air (2x)
- 5 Concentric flue connection appliance; Ø100-150 mm for a vertical roof outlet
- 6 Concentric flue system; Ø100-150 mm for a vertical roof outlet
- 7 Built in operating unit with gas regulator block and receiver

When fitting the appliance, it can be levelled with the adjustable feet.  
These adjustable feet can be reached via the openings (4x), after removing the protective covers, in the corners of the floor of the combustion chamber.  
The floor of the combustion chamber can be reached after the window and the grill around the burner have been removed (see chapter 4).  
Using an Allenkey (no. 5), the appliance can be adjusted to the required height.



Press the 4 protecting covers back into the floor.



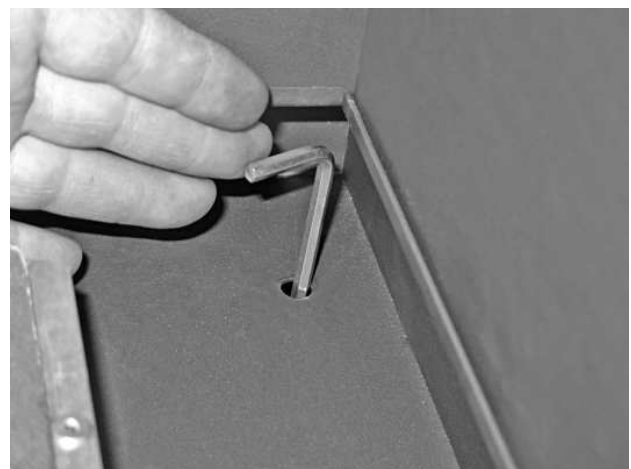
- Position 4 protecting covers.



- Protecting cover.



- Adjustable feet seen from the bottom of the appliance.



- Adjust height with Allenkey no. 5.

Position the gas supply pipe such that it can be easily mounted after installation.

Because the control system is outside the appliance, the gas pipe must lead to where the operating unit (built in), the gas regulator block (and the receiver) assembly are fitted.

Move the appliance until it is  $\pm 5$  cm from the rear wall and ensure it is level. Place the nonflammable insulation plate (min. 12 mm) between the appliance and rear wall. The appliance may not be installed against a flammable rear wall.

Attach the appliance to the rear wall with 2 wedge bolts. Use the adjustable mounting brackets at the side of the appliance for this.



- 2x Mounting bracket.

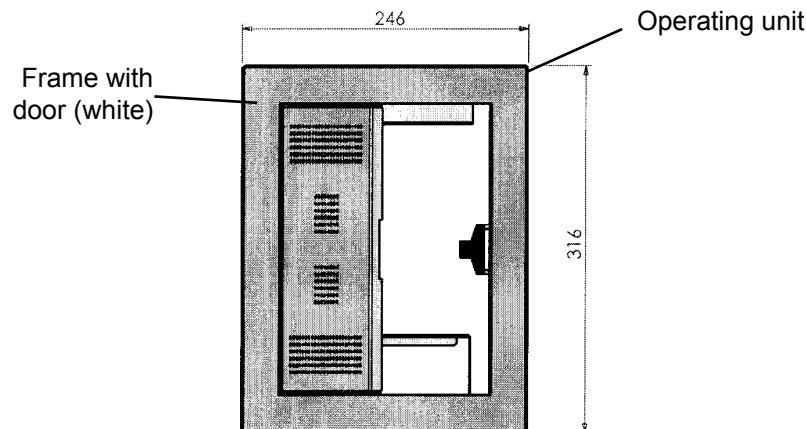
### 1.7.1 Gas connection operating unit

**Important:**



**During gas connection, take care not to twist the gas regulator block. Make sure that both the gas regulator block and the supply pipes are not subjected to stresses.**

The appliance is supplied with a built-in operating unit.



**Figure 18: Operating unit**

Remove the decorative edging and door of the operating unit.

Fit the separate operating unit, where the gas regulator block and receiver will be placed, on max. 50 cm from the appliance.

The burner, gas regulator block and receiver have been fully factory assembled.

Disconnect the bracket with the gas regulator block and receiver from the appliance. Carefully move the bracket with the gas regulator block, receiver, pipes and cables to the operating unit. Mount the bracket at the bottom of the operating unit.

**Important:**



**Take care that no pipes get damaged and no compression fittings come loose when moving the gas regulator block. Prevent twisting the flexible pipes! Check all compression fittings for leaks afterwards!**

Mount the receiver in the top of the operating unit. Check afterwards that all electric connections are properly connected.

General:

Route all piping and cables from the operating unit to the appliance through an easily accessible hollow cavity.

During subsequent installation of the operating unit, protect the gas regulator block and piping against encasement by cement etc.

**Important :** Cement and chalk can damage the piping and can, in turn, lead to gas leaks.



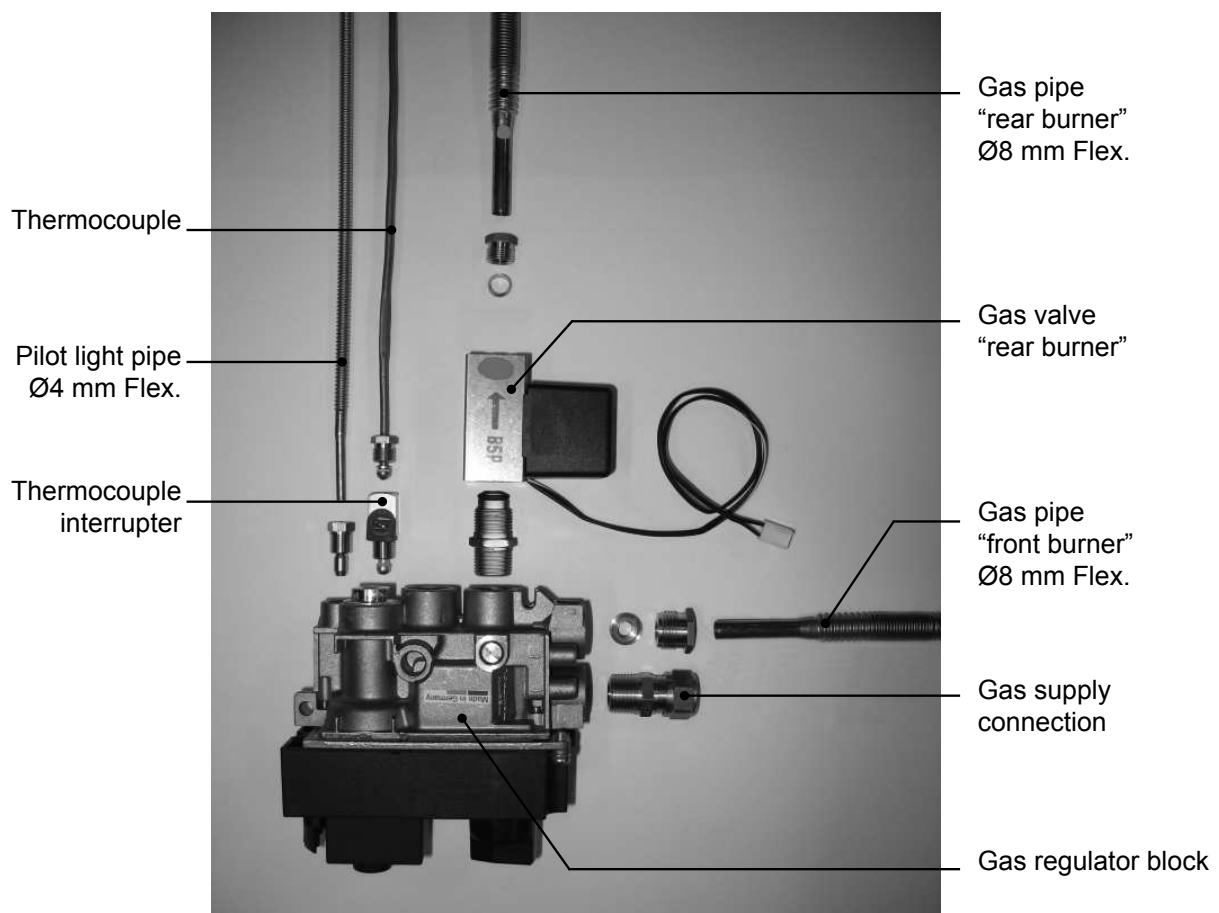
Disassembly and assembly of pipes and cables:

If necessary for mounting, all pipe compression fittings and cable connectors can be temporarily disassembled. After mounting, carefully reassemble all pipes and cables. Check afterwards all compression fittings for leaks and that all electric connections are properly connected.

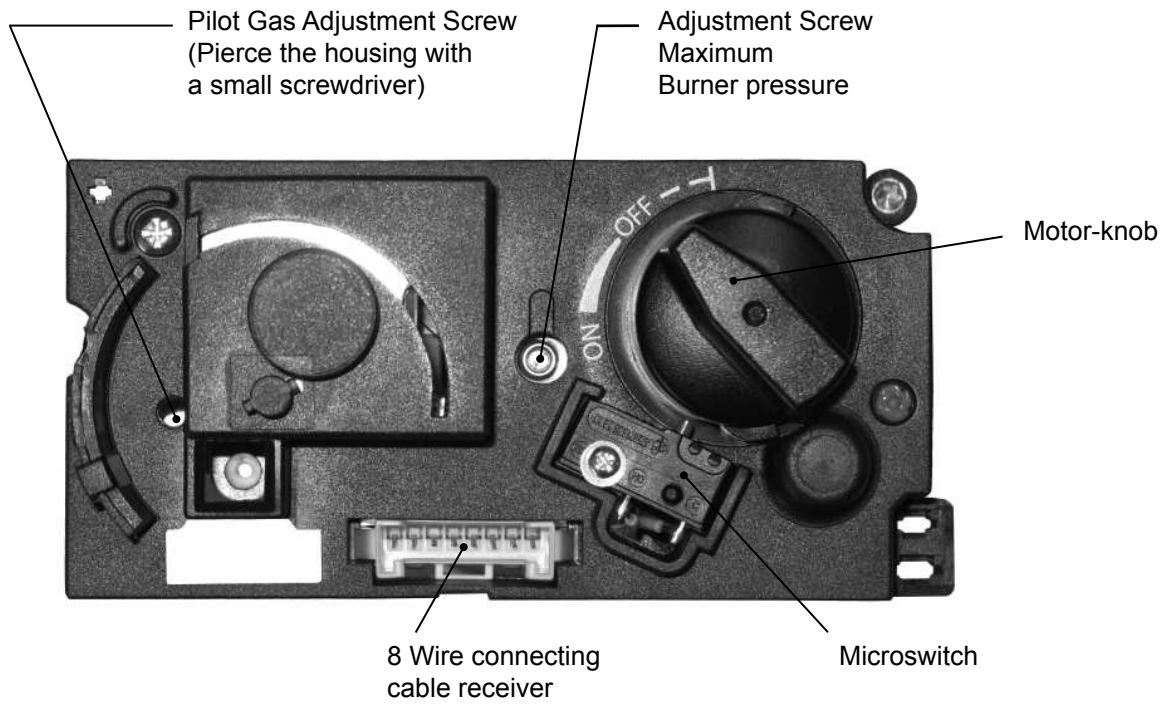
**Important :** Screw the thermocouple connection (and thermocouple interrupter) manually into the gas regulator block. Afterwards, carefully fasten a half turn with a spanner.



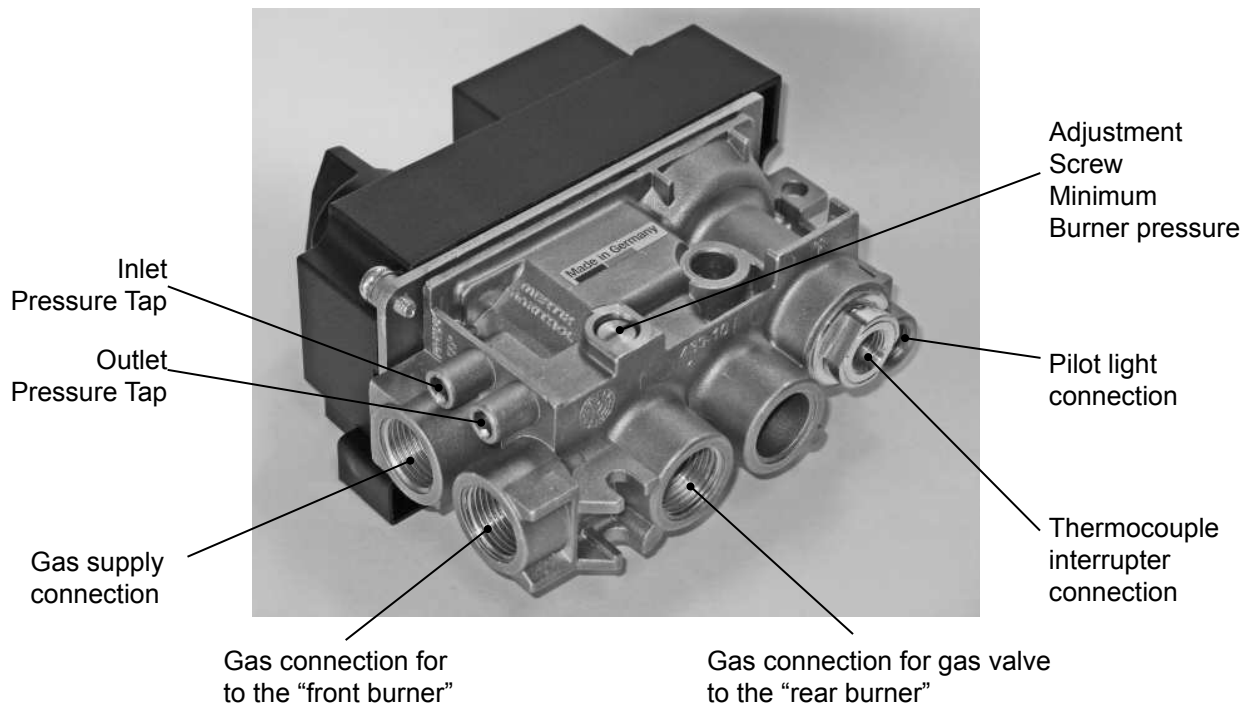
**Note :** Check that the flexible burner pipes are correctly connected! The gas connection of the gas valve “rear burner” must be connected to the “rear burner”! See Chapter 5. Switching over the flexible burner pipes during assembly can lead to an explosive ignition. Prevent this at all costs!



**Figure 19: Gas regulator block and gas valve: Gas and thermocouple connections**



**Figure 20: Gas regulator block - Front**



**Figure 21: Gas regulator block - Rear**

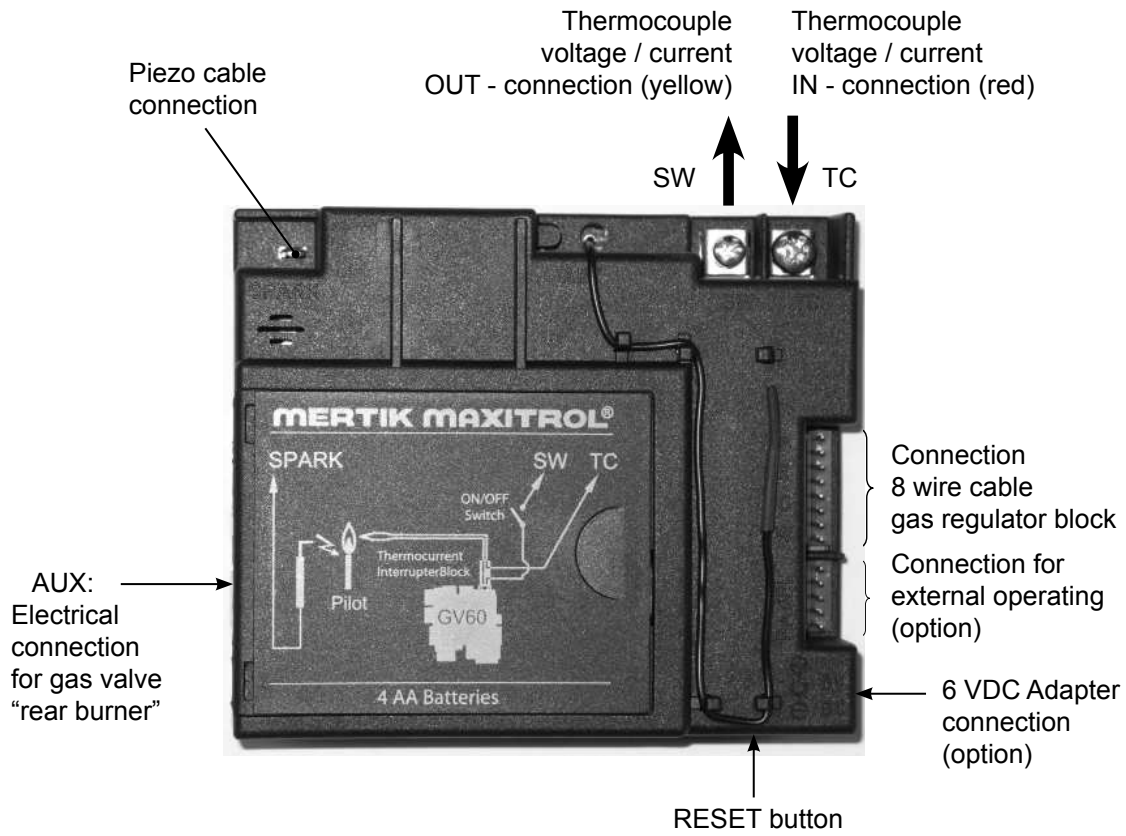


Figure 22: Receiver - Top

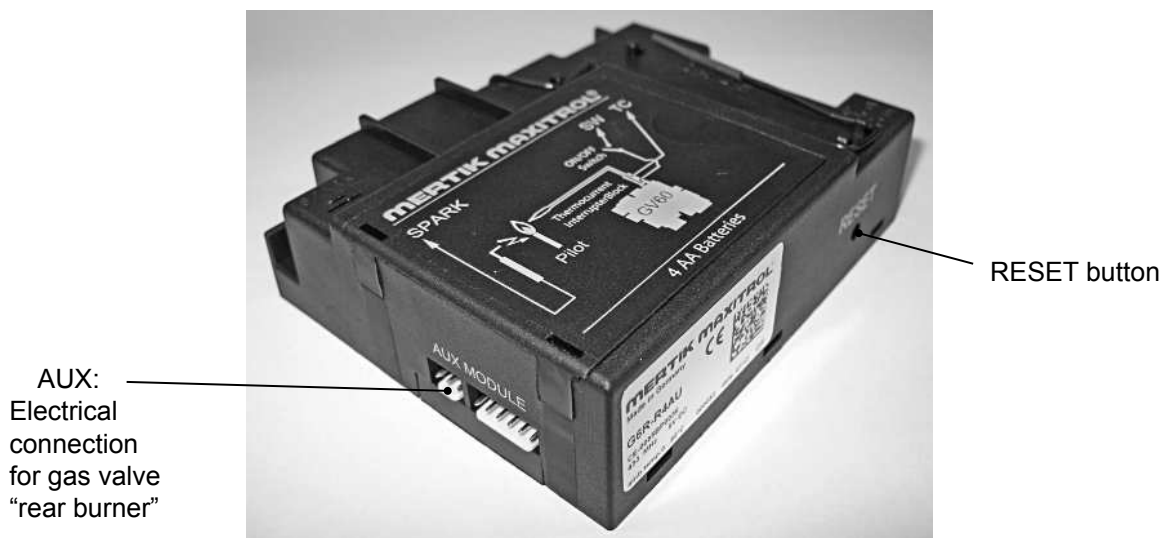


Figure 23: Receiver - AUX connection - RESET button



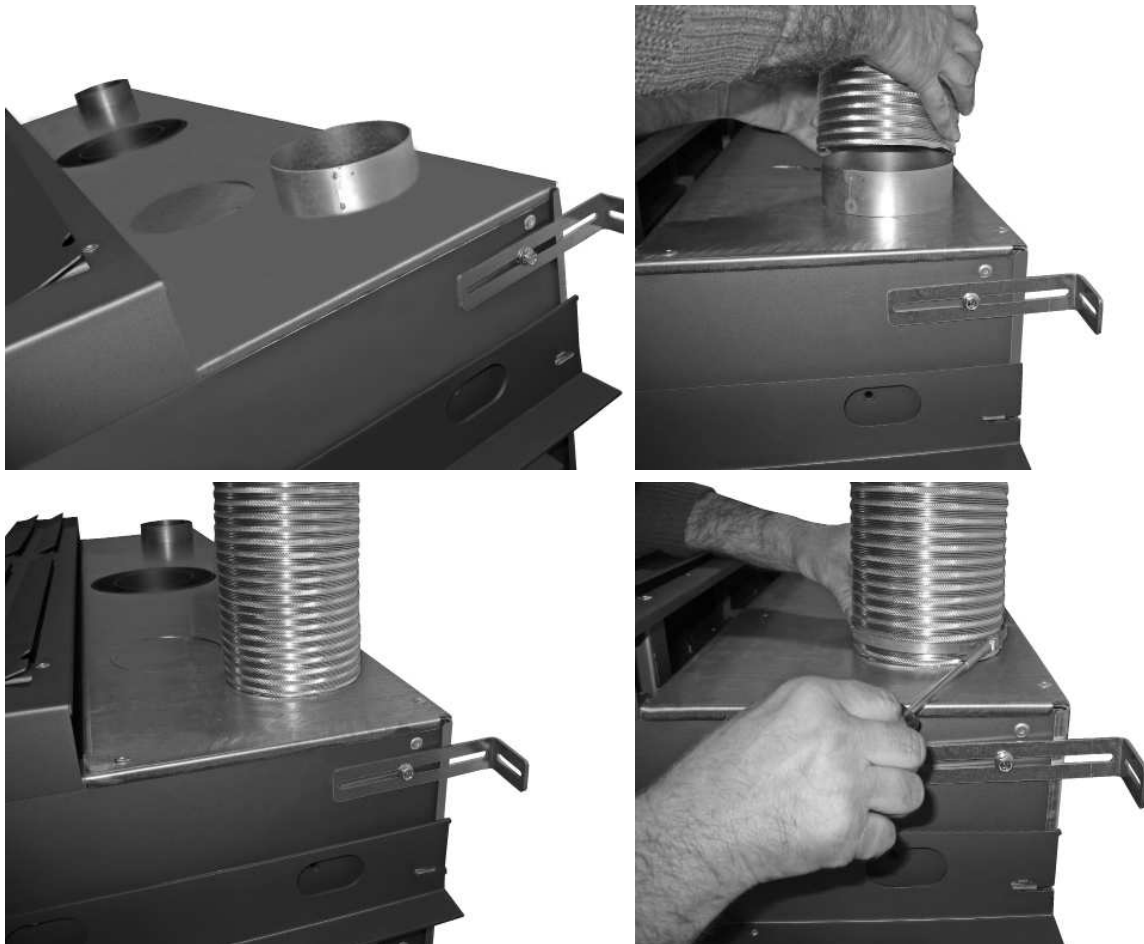
## 1.7.2 Connecting the concentric flue

Assemble the concentric flue system according to one of the examples in section 1.6.1, figure 4 to 14 inclusive.

Make sure that all connections are completely gas tight.

### 1.7.2.1 Mounting the convection package (option)

The convection package (option) consists of a convection casing and a convection set. The convection set is supplied separately and consists of two flexible aluminium pipes, hose clamps and two built-in convection grills (fitting box and grill).



Mount the aluminium pipes on the collar adaptors of the convection top plate. Use the supplied hose clamps. The flexible aluminium pipes are stretchable to a length of  $\pm$  3 meter.



Position the two fitting boxes in the fireplace, at a minimum distance of 30 cm under the ceiling. Mount the other end of the aluminium pipes onto the fitting boxes. To do this use the hose clamps supplied. When the fireplace is completely finished, mount the grilles onto the fitting boxes.



Within a range of 30 cm either side and 50 cm above the escape opening, there must be no flammable materials (e.g. wooden ceiling, fitted furniture).

### 1.7.3 Building in the appliance

Remove the front of the casing, if applicable. (See Chapter 4: Dismantling / Assembling of the glass.)

Decide on positions of the vents (grilles above and below the fireplace) and, if applicable, the hot air grids of the convection package.

The brickwork must be built up around the appliance. In connection with the appliance expanding during burning: there must be at least 3 mm clearance on either side of the appliance. Do not build up the brickwork farther than the angle irons/brackets (keep in mind the thickness of any plastering!).

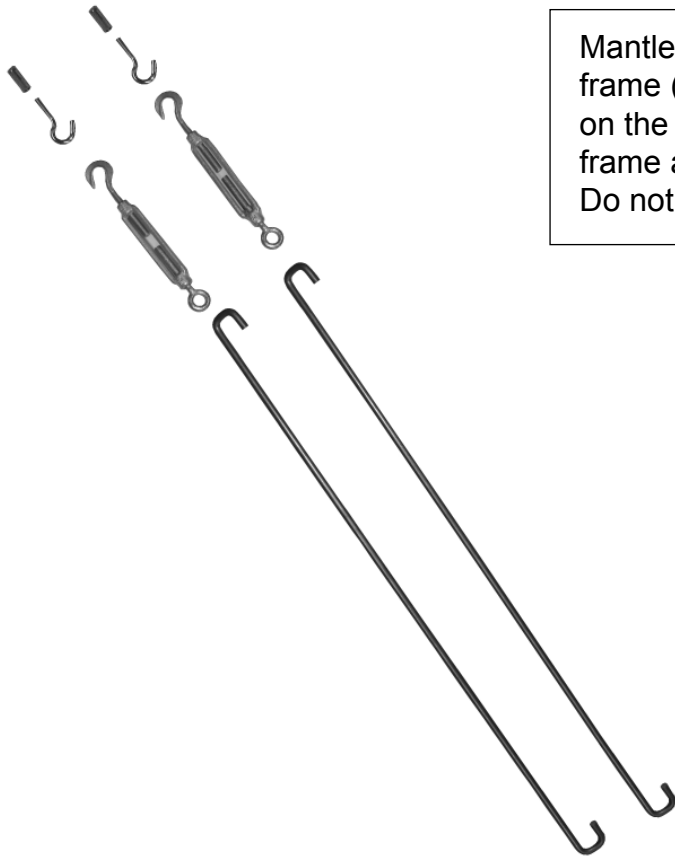


**Do not use masking tape on the appliance when installing and plastering.**  
**Tape can damage the finish of the appliance.**

Connect up the convection package, if applicable. See 1.7.2.1.

### Mantle iron (option).

The optional mantle iron is intended for supporting the brickwork above the appliance. The mantle iron must rest on the brickwork on both sides so that upward building is possible. Level the mantle iron with the supplied bar set.



Mantle iron in combination with the 10 cm frame (option). The mantle iron is screwed on the top panel of the 4 sided 10 cm frame at the factory.  
Do not unscrew this connection !

- Bar set:
- 2x draw bars
  - 2x tension sleeves
  - 2x M6 hooks
  - 2x brass expansion plugs M6

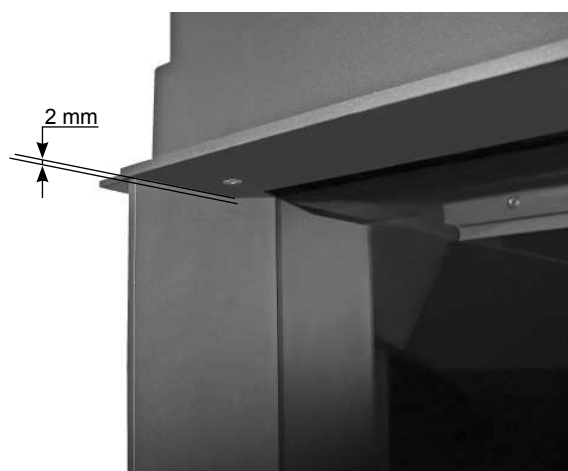


First remove the 2 mantle iron transport-spacers “REMOVE”

**Note!** Temporarily support the mantle iron, so that it does not fall forwards.



Fix the mantle iron to the rear wall with the bar set. Place the draw bars at an angle of about  $60^\circ$  (between the appliance and the wall). Level the mantle iron with the tension sleeves.

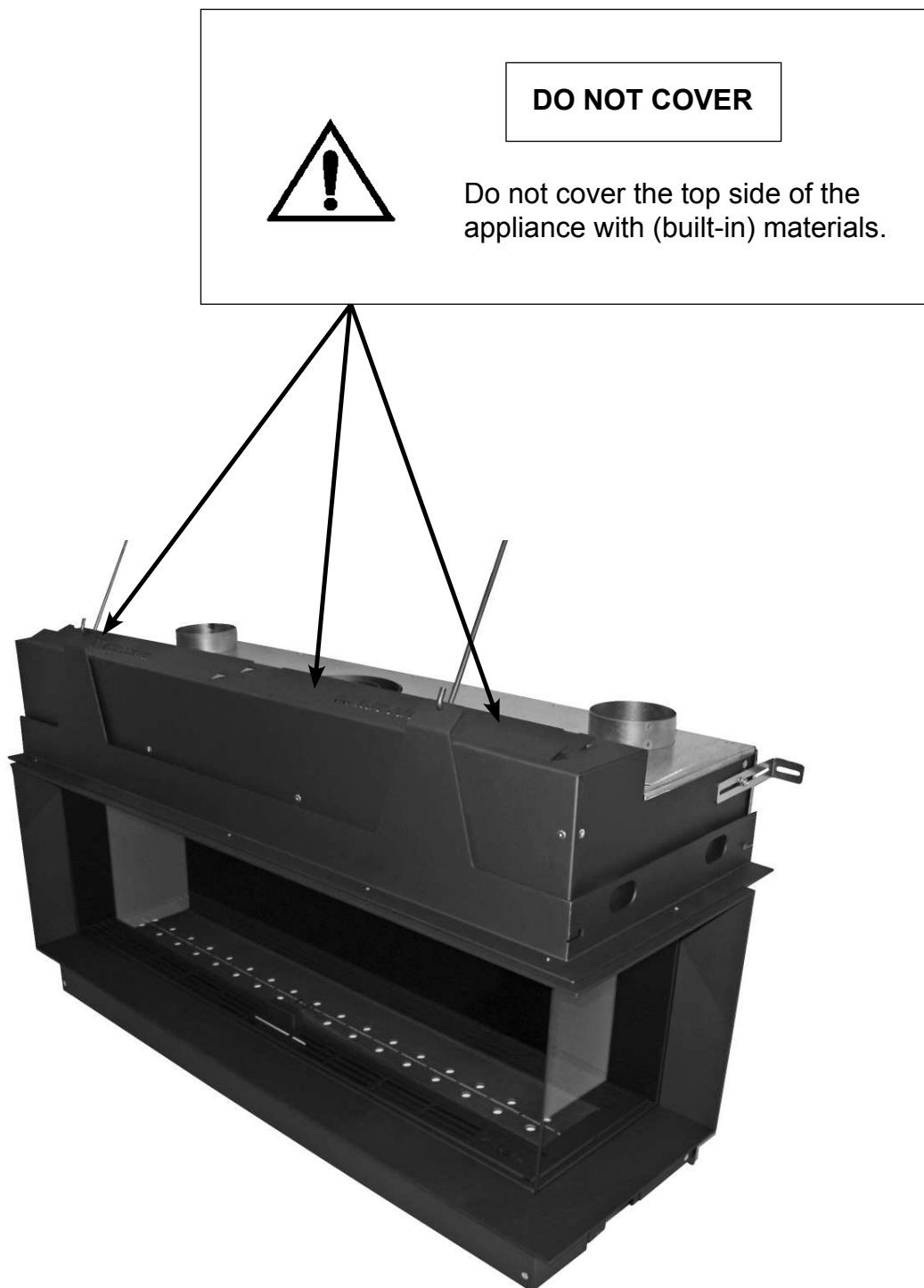


Ensure that the height between the mantle iron and the underside of the glass is the same at left, middle and right.

Keep a clearance of 2 mm between the mantle iron and the top of the side panels. The side panels should always be easily removable. Check that the mantle iron is at right angles to the side panels, both left and right.

Put ceramic felt on the top of the mantle iron, before laying bricks or using other heat-resistant structural materials.

If using other materials, such as stone or heat-resistant plating, you should follow the supplier's instructions.



Once the fireplace has been finished, you can now, fit the frame with the small door to the operating unit.

**After installation in a new fireplace and/or applying new cement work, the appliance cannot be used for at least four weeks.**

### 1.7.4 Checking the gas connection

After connection of the gas supply, check that all connections are completely gas tight using soapy water or a leak tester.

### 1.7.5 Positioning the ceramic log set or marble pebbles

The appliance can be supplied with:

- Ceramic log set + embers
- Marble pebbles white (small, white marble stones)
- Marble pebbles grey (small, grey marble stones)

#### Important:



- **Carefully place the chips of wood/embers/vermiculite granules/ log set or marble pebbles, on and around the main burner according to the directions in this chapter.**
- **Do not place any chips of wood/embers/vermiculite granules/ log set or marble pebbles against the pilot light burner. For that reason, the main burner has a protective pilot-light cowl. Never remove this cowl! Make sure that the pilot flame can burn at all times freely over the main burner. Only in this way is proper ignition of the main burner ensured. Ignoring these directions could lead to a dangerous situation.**
- **Make sure that all burner orifices remains free at all times!**
- **The burner bed (with chips of wood/embers/vermiculite granules) and the positioning of the logs or marble pebbles must not be changed.**
- **Only use those items supplied! These been rigorously checked and the quantities adapted to the appliance.**
- **Replacement parts, including the ceramic mat are available from your dealer.**
- **Fitting may only be carried out by a qualified person.**

Remove the glass according to the instructions in chapter 4; DISMANTLING / ASSEMBLING OF THE GLASS.

### 1.7.5.1 Ceramic log set + chips of wood + embers + vermiculite granules

- 1 Place the ceramic mat on the burner in such a way that the holes in the mat are in line with the burner openings.
- 2 Remove the embers carefully from their packaging and spread them evenly over the burner mat and the grate around the burner.
- 3 Distribute the vermiculite granules (50 gram) evenly over the burner.



Note ! :



- **Small embers and their residue should not be scattered on the burner. This can cause a blockage on the burner orifices.**
- **Embers and vermiculite granules must not be placed next to the pilot light burner.**
- **Important: make sure that all burner openings remain free !! Burner orifices, which are not open, could lead to a dangerous situation.**

4 Place the logs on the burner:

<u>Appliance</u>	<u>Natural gas-burner</u> see figure:	<u>Propane / Butane-burner</u> see figure:
Corner Bell Small 3 L/R CF/LF	24	25

Keep the burner orifices unblocked !!!

5 Place the chips of wood around the burner.



**Logs:**



Log no ①



Log no ②



Log no ③



Log no ④



Log no ⑤



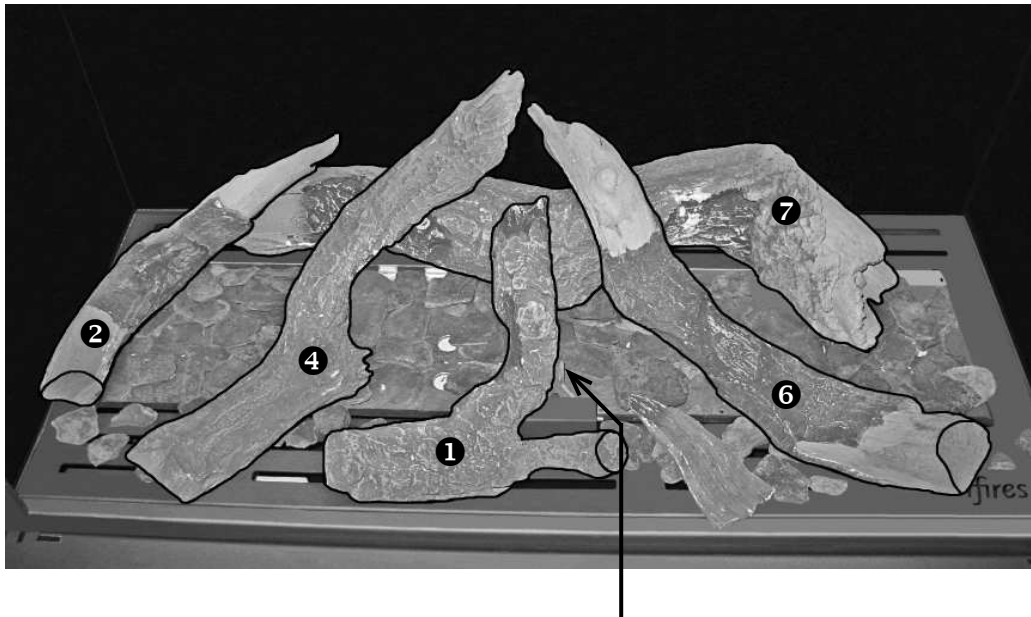
Log no ⑥



Log no ⑦



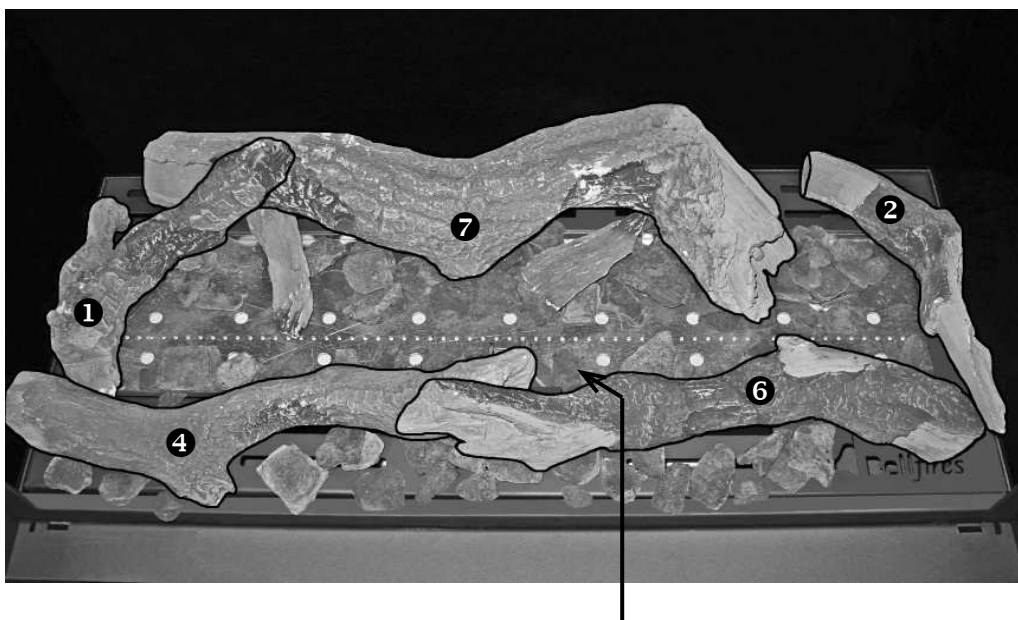
Log no ⑧



Embers must not be placed next to the pilot light burner

Keep the burner orifices unblocked!

**Figure 24: Log set Corner Bell Small 3 L/R CF/LF  
Position natural gas burner**



Embers must not be placed next to the pilot light burner

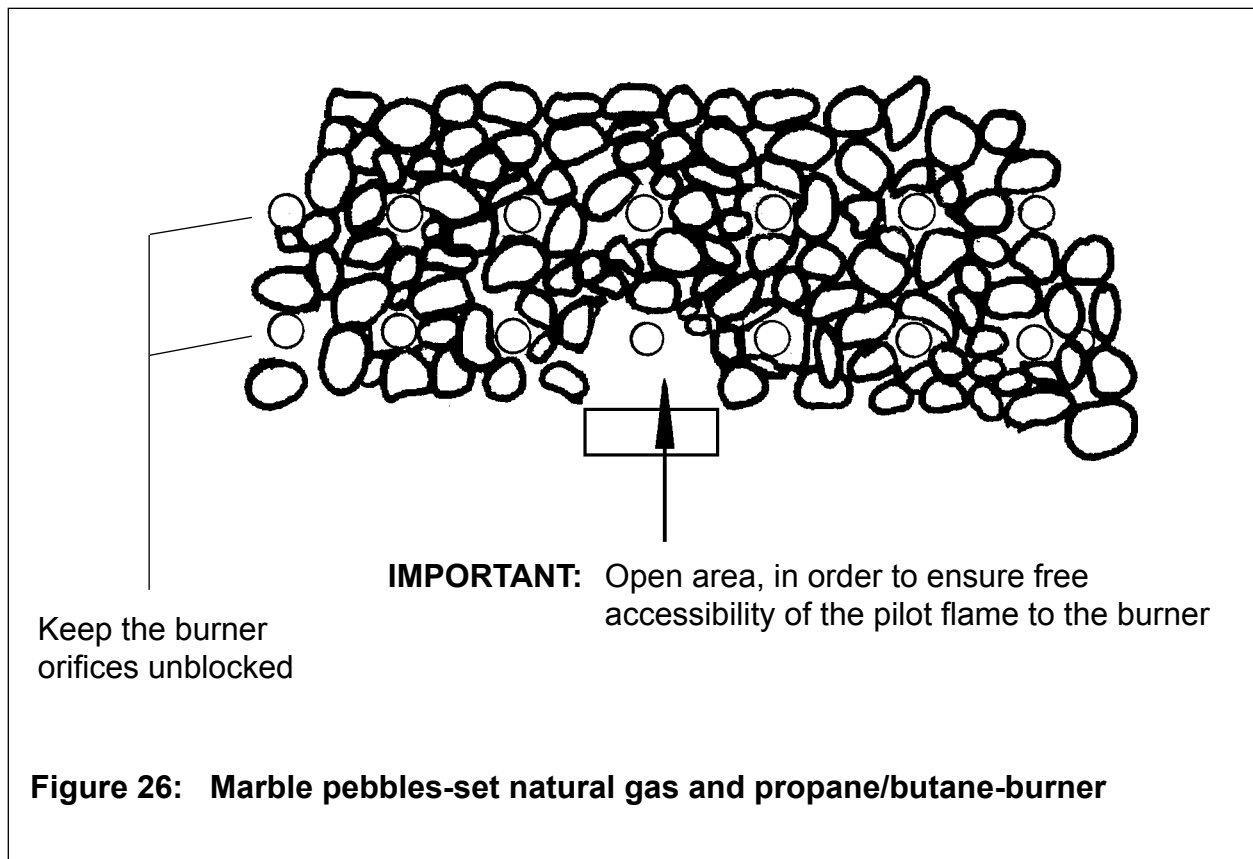
Keep the burner orifices unblocked!

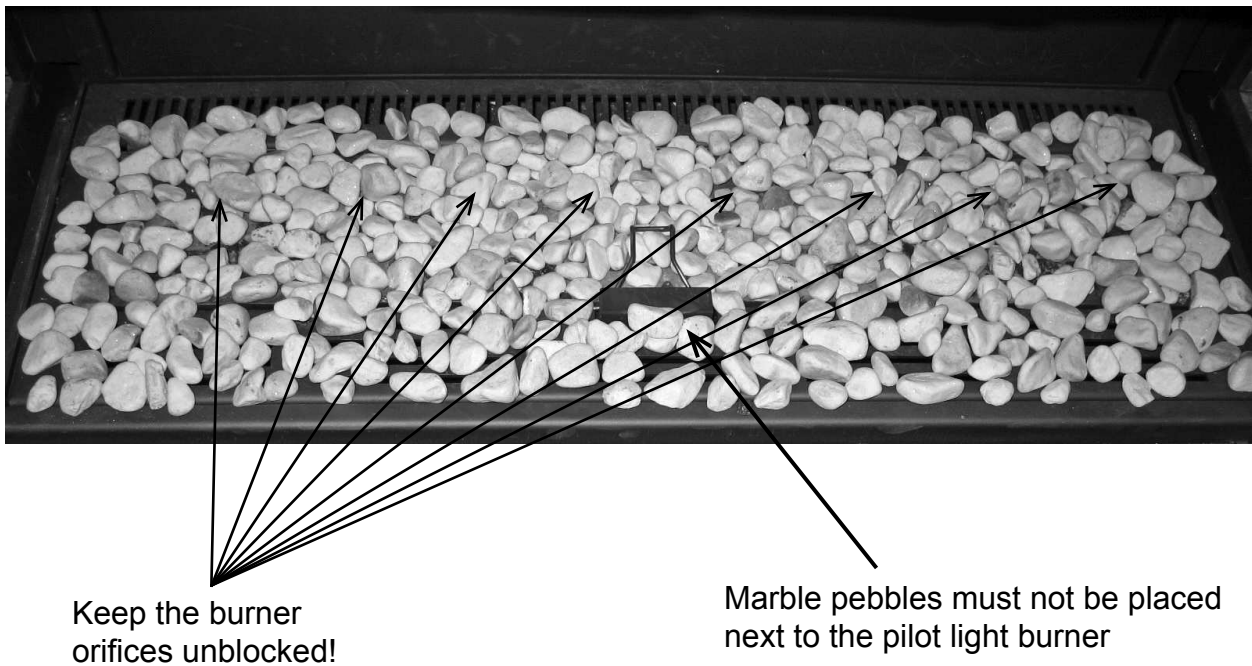
**Figure 25: Log set Corner Bell Small 3 L/R CF/LF  
Position propane/butane burner**

### 1.7.5.2 Marble pebbles

- 1 Place the ceramic mat on the burner in such a way that the holes in the mat are in line with the burner openings.
- 2 Spread the pebbles over the whole burner bed (burner and grid around the burner). Make sure that the pilot light remains free.

Corner Bell Small 3 L/R CF/LF : see figure 27





Keep the burner  
orifices unblocked!

Marble pebbles must not be placed  
next to the pilot light burner

Keep the burner orifices unblocked!

**Figure 27: Marble pebbles Corner Bell Small 3 L/R CF/LF  
Position natural gas and propane/butane burner**

- Important:**
- Do not place any marble pebbles in front of the pilot light. Make sure that the pilot light can burn freely over the main burner.
  - Keep the burner orifices unblocked.



**Only this way a proper ignition of the main burner is ensured.**

Once the logs / marble pebbles have been positioned, replace the glass in the appliance, following the instructions in chapter 4: DISMANTLING / ASSEMBLING OF THE GLASS.

### 1.7.6 Mounting flue gas restriction plate

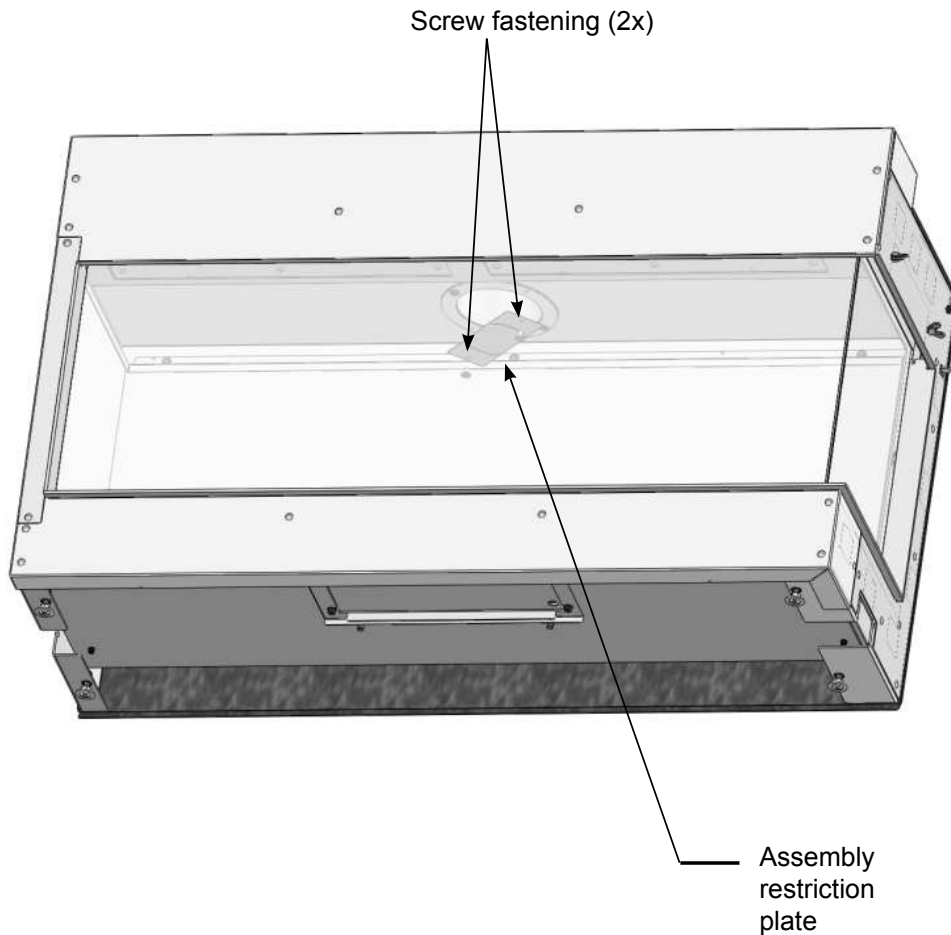
Depending on the length and shape of the concentric flue system and the chimney construction, you should, if indicated, fit a restriction plate with a certain width (B) into the ceiling of the combustion chamber.

To do this, see the set-up options as listed in figure 4 through 14.

**Important:**

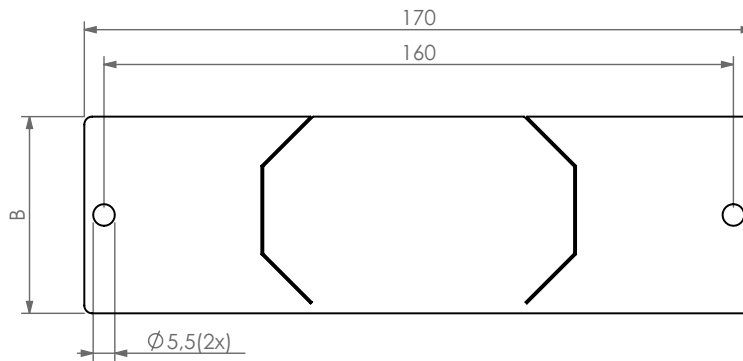


**Ensure that the correct flue gas restriction plate is mounted. Use of the correct flue gas restriction plate will provide optimum efficiency, flame effect and combustion. Mounting an incorrect flue gas restriction plate can result in damage to the gas fire.**



**Figure 28: Positioning restriction plate**

The following restriction plates are supplied:



	Concentric flue connection appliance	
Restriction plate:	[Ø130 - 200 mm] Horizontal wall outlet	[Ø100 - 150 mm] Roof-mounted outlet
Width:	-	B = 30 mm
Width:	B = 40 mm	B = 40 mm
Width:	B = 50 mm	B = 50 mm
Width:	B = 65 mm	B = 65 mm
Width:	B = 80 mm	-

### 1.7.7 Check overpressure hatches

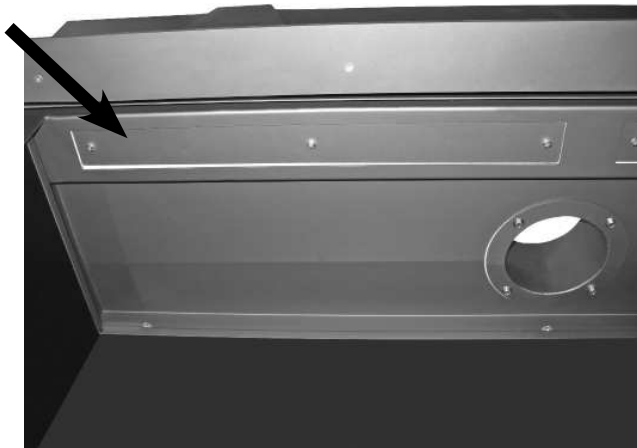
There are two overpressure hatches in the roof of the combustion chamber (front).



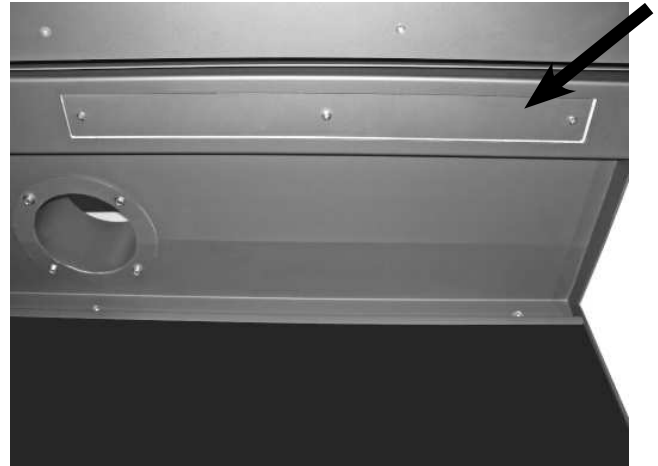
Check that the hatches are loose, by lifting a little and carefully letting them come down again.

Check if the packing under the hatches is sealed.

Left overpressure hatch is in the correct position.



Right overpressure hatch is in the correct position.



Check functioning of overpressure hatch.



Check packing of overpressure hatch.  
If necessary, the packing can be replaced by lifting the hatch, tilting it and removing via the opening.



### 1.7.8 Checking the appliance following installation

After installation, visually check the gas flame. When the fire is ignited, the flames should be short and blue/yellow in colour. These flames should gradually increase in height and become more yellow. When all flames are yellow, the gas fire has reached the correct temperature.

THE GAS FIRE IS NOW READY FOR USE

## 2 MAINTENANCE

### 2.1 ANNUAL MAINTENANCE



It is **essential** that the appliance, the complete concentric flue system (where possible) and the outlet are cleaned and inspected **annually** by a recognised fitter/gas specialist. The safe operation of the appliance will thus remain guaranteed.

Maintenance consists of the following:

- Remove first the embers, vermiculite granules, logs set or pebbles from the main burner and carefully clean these with a soft brush.
- Clean and inspect (visually) the main burner, pilot light, combustion chamber, flue system and combustion air intake. Dust can be removed using a vacuum cleaner.
- Clean the glass on the inside of the appliance with glass spray or ceramic hob cleaner. This also applies to the black mirror rear wall and side panels, if the appliance is fitted with these.

- After cleaning;  
Carefully replace the embers, vermiculite granules, logs set or pebbles on and around the main burner according to the installation directions in this instruction booklet.

**Do not place any embers, vermiculite granules, logs or pebbles against the pilot light burner. Make sure that the pilot flame can burn at all times freely over the main burner. Only in this way is proper ignition of the main burner ensured. Ignoring these directions could lead to a dangerous situation.**

- Check the gas supply, flue system, and combustion air supply route for leaks.
- Check the correct operation of the gas regulator block, thermocouple circuit and the ignition of the main burner.
- Check the gas inlet-pressure (both when the appliance is off and when it burns at maximum) and the burner pressure.
- Check if the overpressure hatches are correctly positioned and check if the packing seals properly under the hatches.
- Check the complete concentric flue system including the outlet construction. A camera can be used to inspect the whole length of the flue gas outlet and the combustion air intake. Also check that all connections are secure.



### **3 FAULTS**

#### **3.1 POSSIBLE REASONS**

Possible reasons for the gas fire going out are:

- The concentric flue system is not installed according to one of the methods detailed in Paragraph 1.6.
- An incorrect “flue gas restriction plate” is fitted.
- The pilot light extinguishes if fumes are not exhausted or are insufficiently exhausted.
- The pilot light is either dirty or defective.
- Insufficient gas pressure.
- (Internal) leak of the concentric flue system.
- Thermocouple voltage is too low. This is usually caused by insufficient heating of the thermocouple by the pilot light.
- Dirty electrical contacts in the thermo-electrical system; for example, the thermocouple connection.
- Batteries in receiver or remote control are flat.

#### **3.2 SAFETY MEASURES IN THE APPLIANCE**

##### **3.2.1 Thermo-electric pilot light shut off**

The appliance is protected by means of a thermo-electric pilot light shut off in the event of a gas escape from the main burner.

##### **3.2.2 Over pressure safety system**

The appliance is fitted with a patented safety system, whereby the door will extract any over-pressure that arises in a controlled way. In this, a spring system briefly causes the door to hinge forward a few centimetres. A loud noise can occur.

A safety strip limits the maximum degree to which the door can be tilted.

If an over-pressure situation occurs, the appliance should be thoroughly checked by the installer.

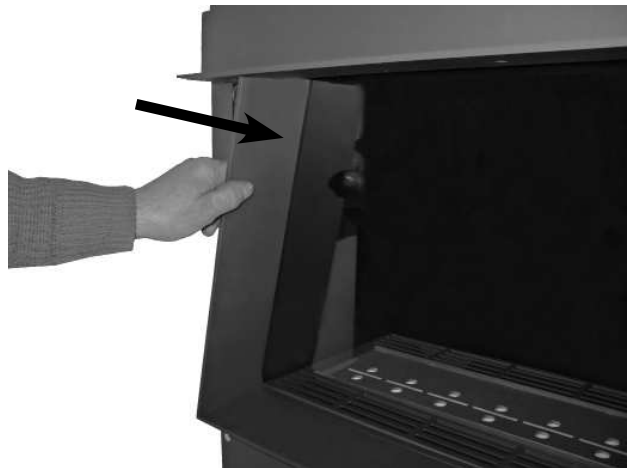
## 4 DISMANTLING / ASSEMBLING OF THE GLASS

### 4.1 CORNER BELL SMALL 3 L/R HIDDEN DOOR (10 cm frame (4 sided))

#### Dismantling of the glass:

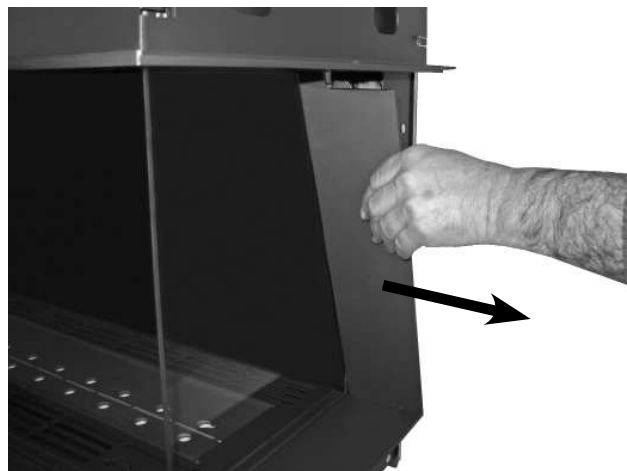
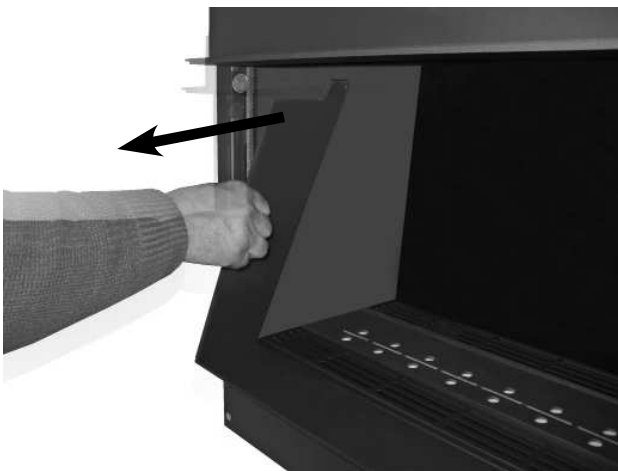
Place paperboard on the chimney breast, under the appliance.

This helps prevent damage.



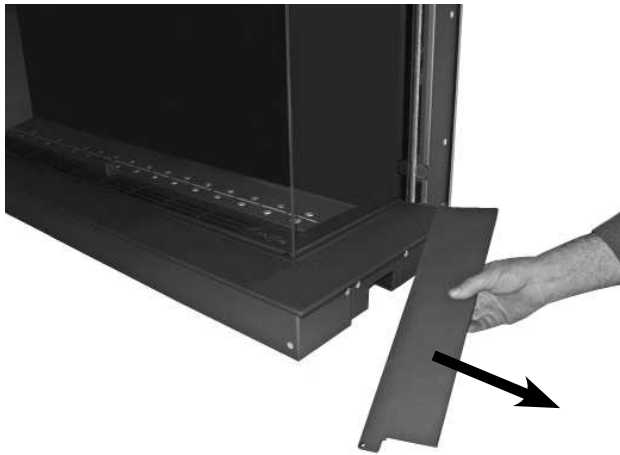
- Corner Bell Small 3 - Right.

- Pull the side panel forwards on the long side, alongside the glass.



- Remove the side panel on the long side.

- Pull the side panel forwards on the short side, alongside the glass.



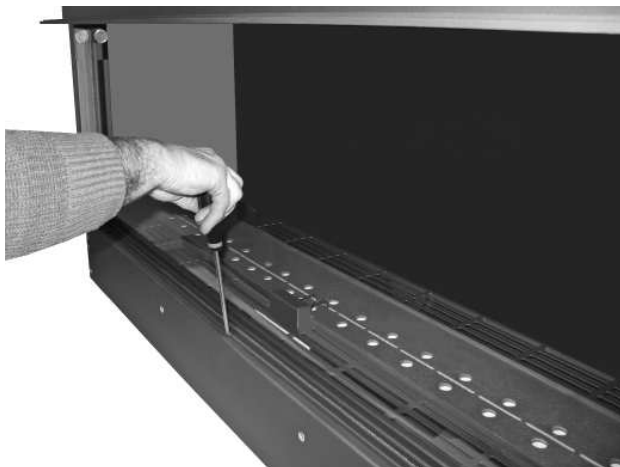
- Remove the side panel on the short side.



- Remove the bottom panel .



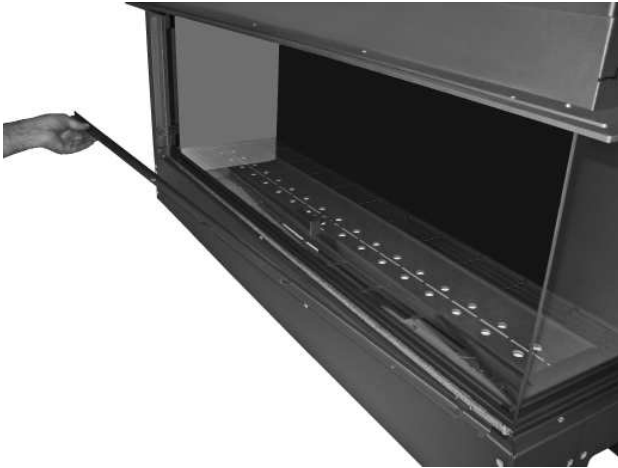
- Remove the bottom panel.



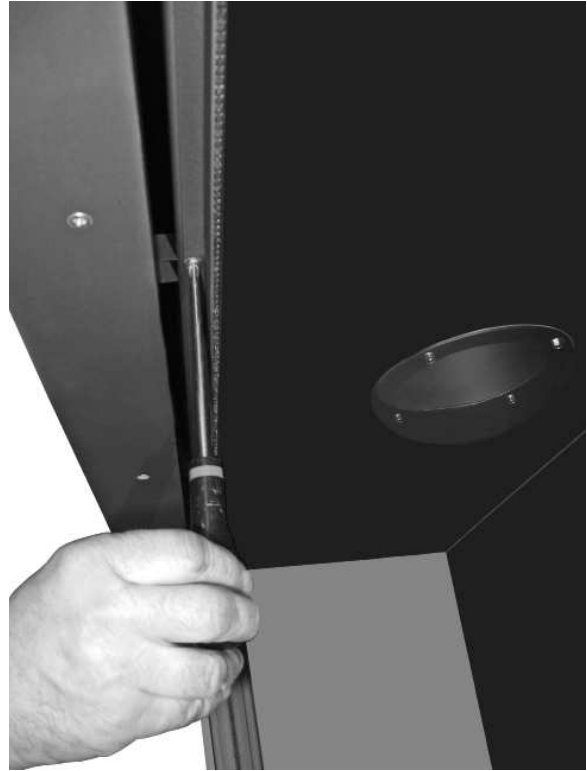
- Unscrew the strip at the front under the glass. Screws only need a couple of turns!



- Using a screwdriver, slide the strip a little to the left.



- Remove the strip at the front.



- Unscrew the long strip at the top a little and leave the strip in place.



- Pull the glass carefully forwards at the bottom, and slide it a little to one side.



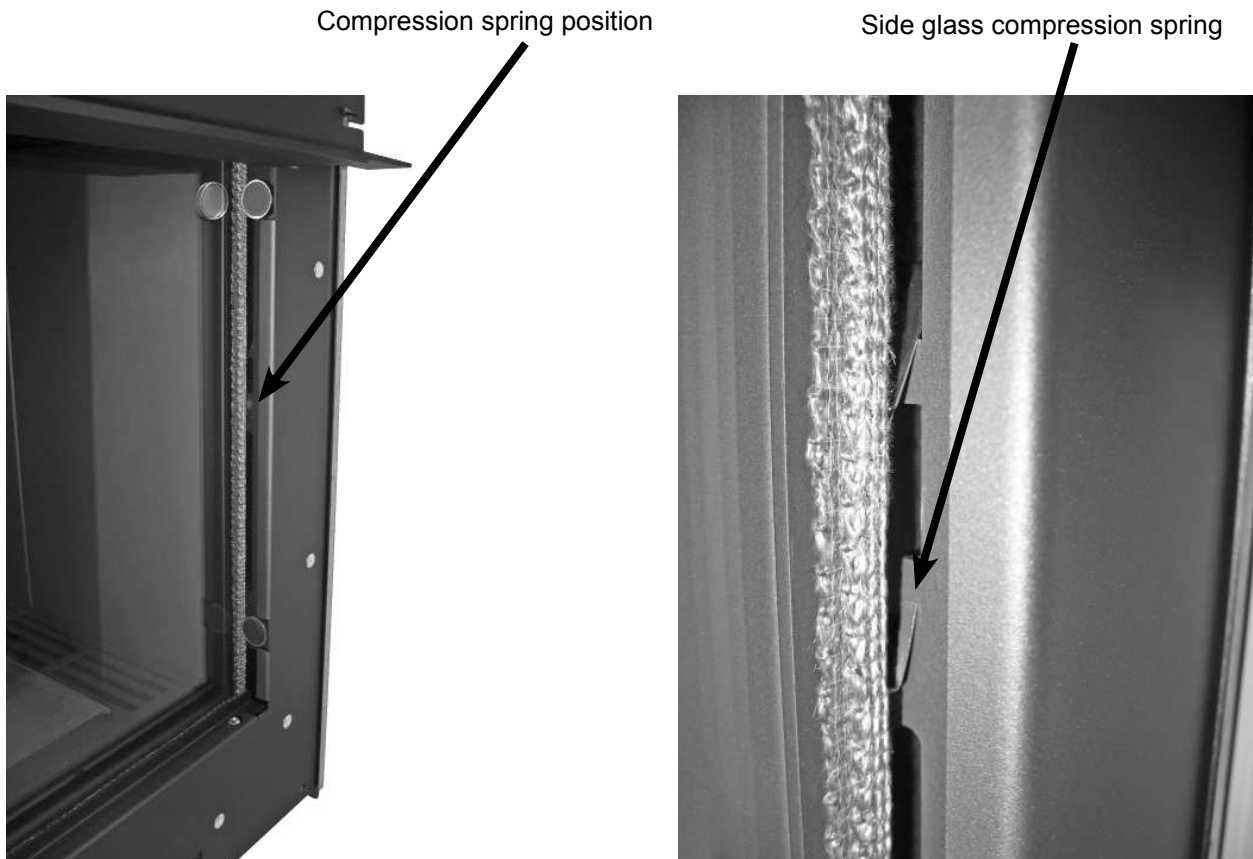
- Lift the glass carefully and pull it forwards a little at the bottom.



- Remove the glass by slanting it forward a little at the bottom and taking it out.



- The glass at the sides can be removed in the same way as the front glass.



- Make sure that the compression spring stays in the correct position.
- Side glass compression spring.

**All fastening strips on the top side remain in position!**

#### Assembling of the glass:

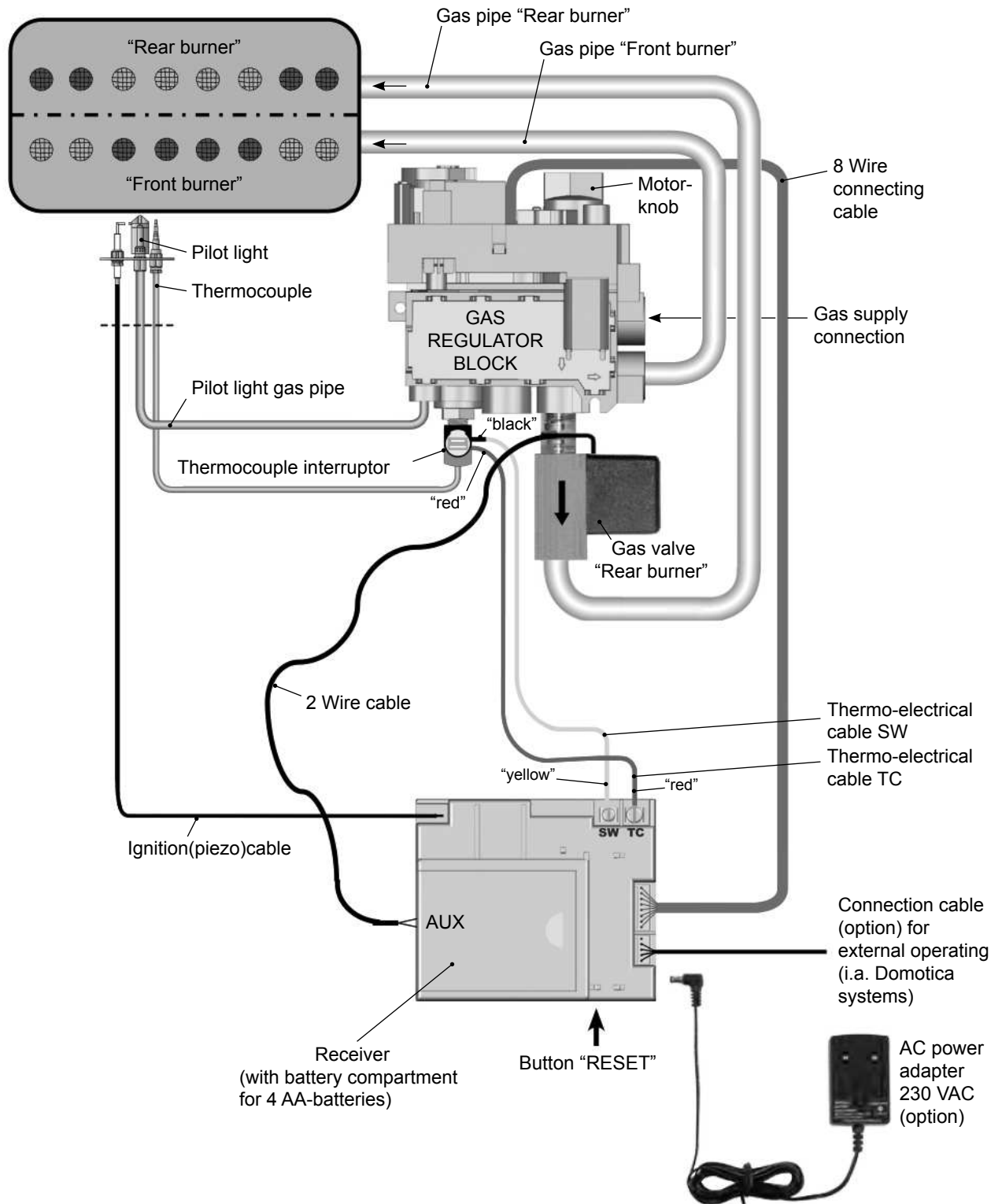
The assembly of the glass takes place in reverse order.

#### **Important:**

- The glass panes fit together well. There must be no gaps between the glass panes, or there will be a danger of flue leakage.
- The glass panes must fit properly all round the edges of the combustion chamber.
- Check if the fastening strips have been properly mounted all round.
- Check if the compression spring has been replaced in the correct position.

5 DIAGRAM ELECTRICITY AND GAS

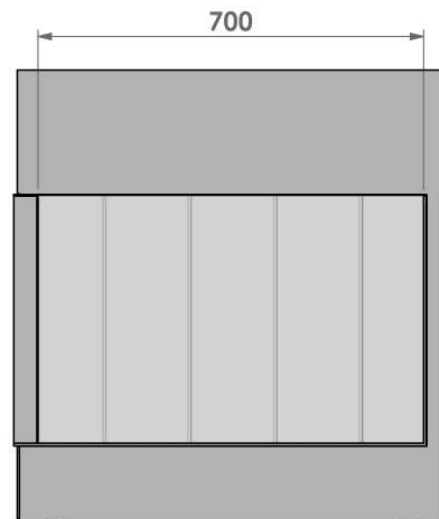
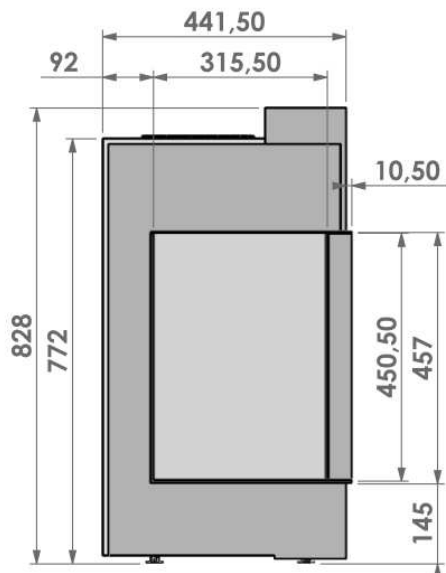
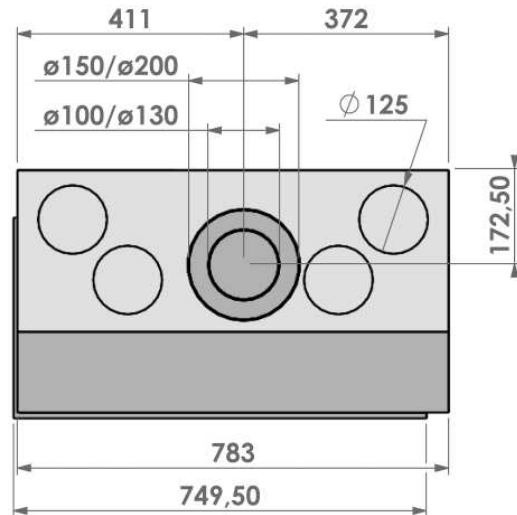
Double burner: ● : Perforation pattern "Centre Fire" double burner.  
 ● + ● : Perforation pattern "Line Fire" double burner.



6 DIMENSIONS

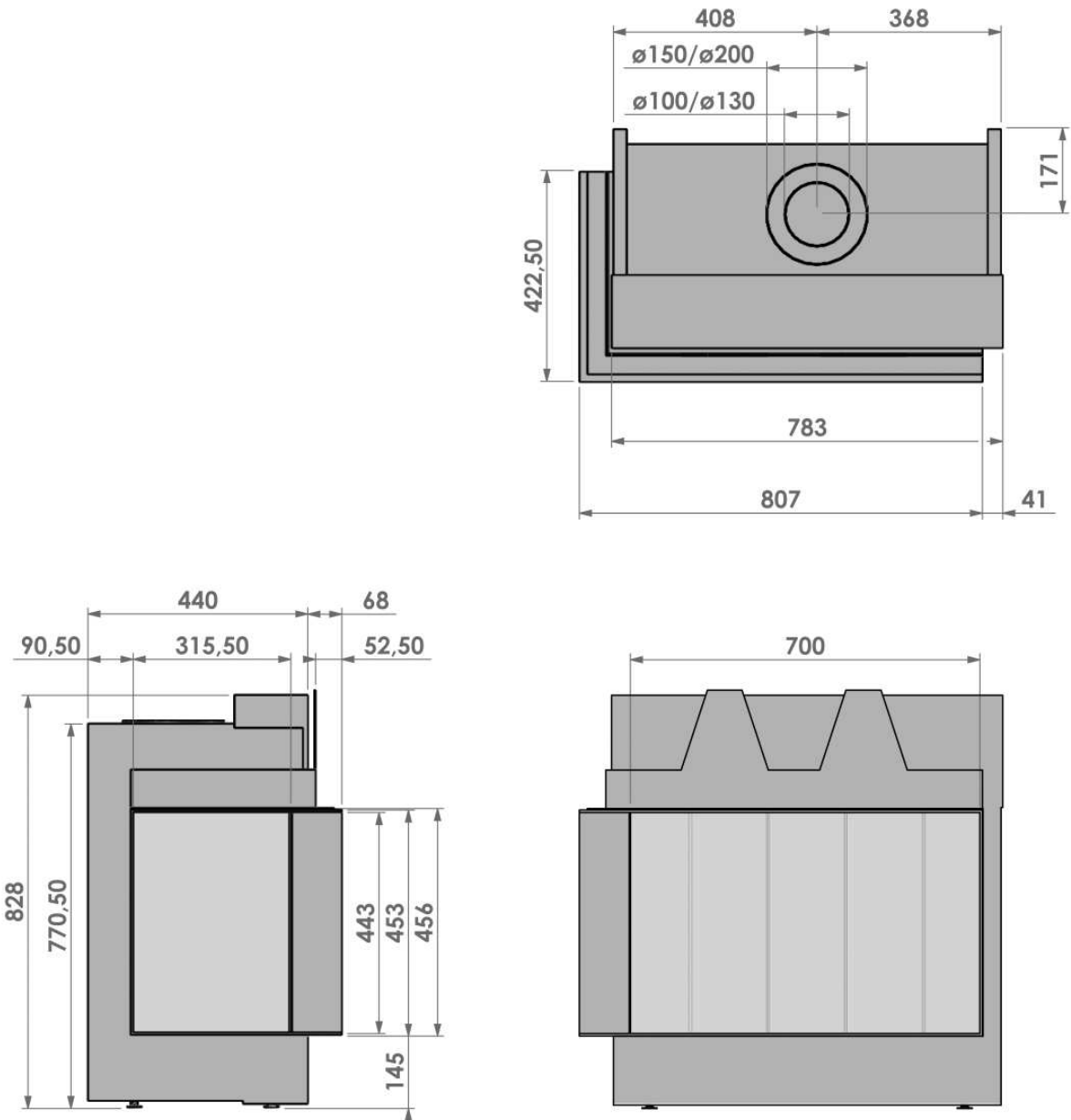
6.1 CORNER BELL SMALL 3 L

6.1.1 CORNER BELL SMALL 3 L - Hidden Door  
 Fitted with the options: Convection casing



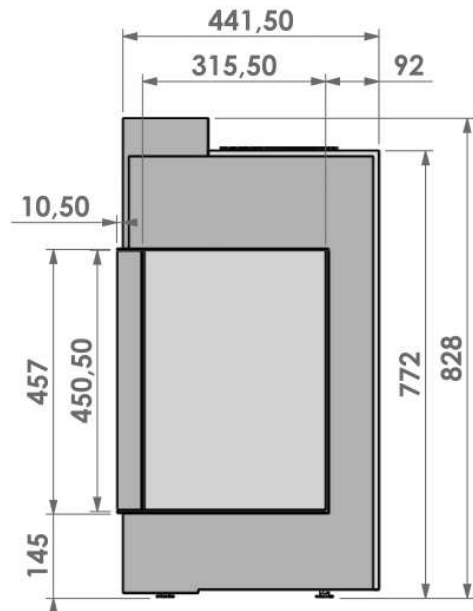
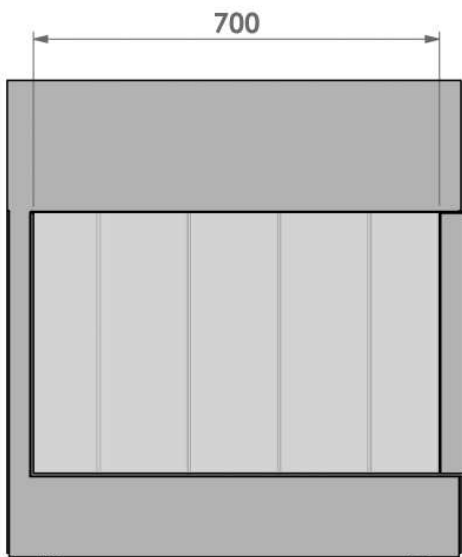
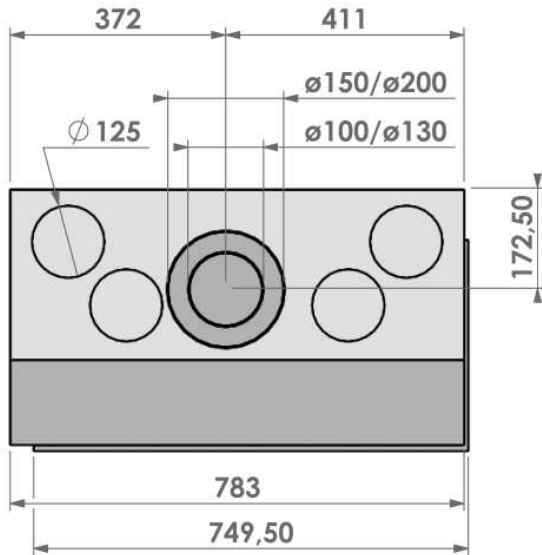


6.1.2 CORNER BELL SMALL 3 L - Hidden Door + 10 cm Frame

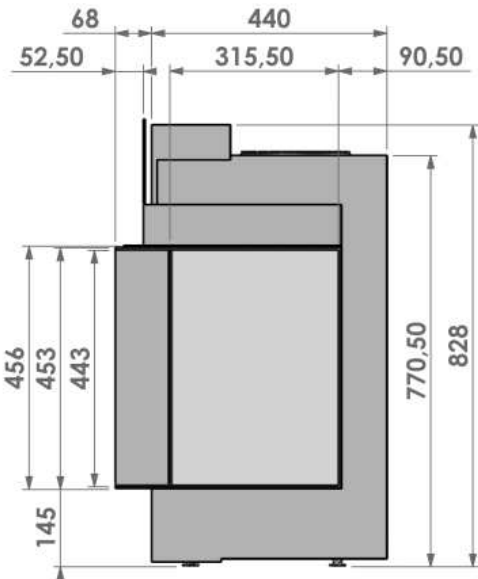
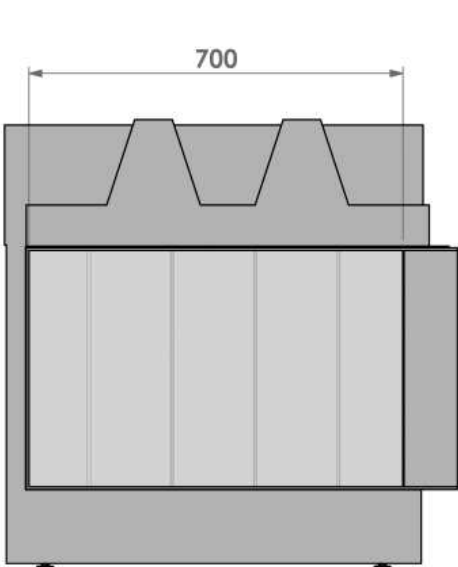
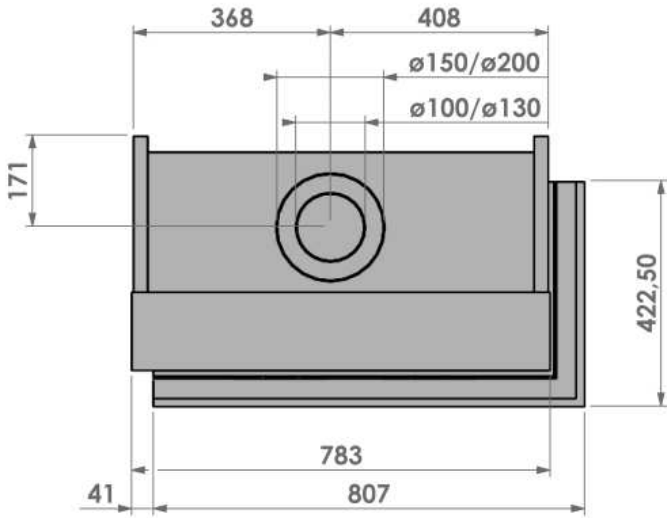


6.2 CORNER BELL SMALL 3 R

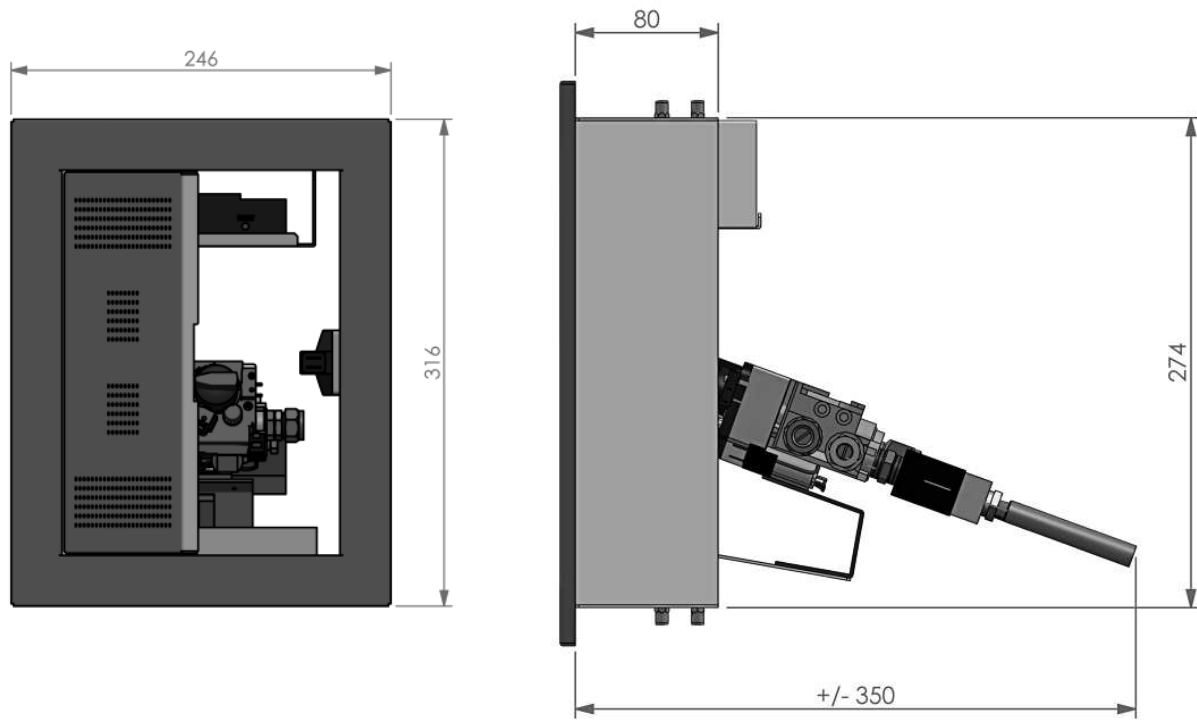
6.2.1 CORNER BELL SMALL 3 R - Hidden Door  
Fitted with the options: Convection casing



6.2.2 CORNER BELL SMALL 3 R - Hidden Door + 10 cm Frame



OPERATING UNIT



## 7 TECHNICAL DETAILS/REGULATIONS

### National installation regulations:

- Gas safety installation and use regulations 1998 plus all relevant safety and building regulations concerning fire installation
- Document J: Combustion appliances and fuel storage systems

<b>Model</b>	<b>: CORNER BELL SMALL 3 L/R CF (Centre Fire)</b>	
<b>Gas</b>	<b>: NATURAL GAS</b>	<b>: BUTANE / PROPANE</b>
<b>Country</b>	<b>: GB; Great Britain/IE; Ireland</b>	<b>: GB; Great Britain/IE; Ireland</b>
Product identification no	: 0063CM3684	: 0063CM3684
Type of appliance under CE-norm	: C <sub>11</sub> / C <sub>31</sub> / C <sub>31S</sub>	: C <sub>11</sub> / C <sub>31</sub> / C <sub>31S</sub>
Category of appliance	: I <sub>2H</sub> natural gas G20	: I <sub>3B/P</sub> butane/propane G30/G31
Nominal heat input (Gross calorific value)	: 10.2 kW	: Butane (G30) : 10.0 kW Propane (G31) : 8.5 kW
Nominal heat output	: 7.9 kW	: 6.6 - 7.7 kW
Efficiency class	: 1 (85%)	: 1 (85%)
NOx-class	: 5	: 5
Gas rate (max.)	: 0.97 m <sup>3</sup> /hr.	: Butane (G30) : 750 gr/hr. Propane (G31) : 620 gr/hr.
Supply pressure	: 20.0 mbar	: Butane (G30) : 37.0 mbar Propane (G31) : 37.0 mbar
Burner pressure (max.) Hot	: 13.2 mbar(*)	: 29.0 mbar(*)
Burner pressure (max.) Cold	: 12.5 mbar(**)	: 29.0 mbar(**)
Burner pressure (min.)	: 1.0 mbar(***)	: 1.0 mbar(***)
Primary air inlet burner Rear	: 1x Ø12.0 mm	: 1x Ø20.0 <sup>corner</sup> mm + 2x Ø5.0 mm
Primary air inlet burner Front	: 1x Ø12.0 mm	: 1x Ø20.0 <sup>corner</sup> mm + 2x Ø5.0 mm
Gas regulator block (remote control)	: Mertik GV 60	: Mertik GV 60
Main burner	: Centre Fire 561x130 mm	: Centre Fire 561x130 mm
Main burner injector Rear	: no 190 (= 1x Ø1.90 mm)	: no 95 (= 1x Ø0.95 mm)
Main burner injector Front	: no 190 (= 1x Ø1.90 mm)	: no 115 (= 1x Ø1.15 mm)
Pilot light burner	: SIT 0.145.019	: SIT 0.145.019
Pilot light burner injector	: no 36 (SIT 0.977.091)	: no 23 (SIT 0.977.150)
Gas connection	: 3/8" G / Ø12 mm	: 3/8" G / Ø12 mm
Concentric flue system connection	: Ø100 mm - Ø150 mm or Ø130 mm - Ø200 mm	: Ø100 mm - Ø150 mm or Ø130 mm - Ø200 mm

<b>Model</b>	<b>: CORNER BELL SMALL 3 L/R CF (Centre Fire)</b>	
<b>Gas</b>	<b>: NATURAL GAS</b>	<b>: BUTANE / PROPANE</b>
<b>Country</b>	<b>: GB; Great Britain/IE; Ireland</b>	
<b>Batteries remote control</b>		
- Receiver	: 4x 1.5V AA	: 4x 1.5V AA
- Hand-transmitter	: 1x 9V block	: 1x 9V block
<b>Weight:</b>		
- Basis model: Hidden Door	: 82 kg	: 82 kg
- Model: Hidden Door with 10 cm frame and mantle iron	: 94 kg	: 94 kg
- Option: Convection package	: 11 kg	: 11 kg

(\*) : Both burners at maximum. Appliance is on temperature.

(\*\*) : Both burners at maximum. Appliance is cold.

(\*\*\*) : Both burners at minimum.

Flue gas exhaust and combustion air supply:

Roof-mounted outlet : Concentric flue system Ø100 mm - Ø150 mm. Rigid and/or flexible.

Horizontal wall outlet : Concentric flue system Ø130 mm - Ø200 mm. Rigid.

With wall outlet, depending on the flue configuration; Ø100 mm - Ø150 mm or  
Ø130 mm - Ø200 mm.

Heat changing surface: Entire front of the appliance.

<b>Model</b>	<b>: CORNER BELL SMALL 3 L/R LF (Line Fire)</b>	
<b>Gas</b>	<b>: NATURAL GAS</b>	<b>: BUTANE / PROPANE</b>
<b>Country</b>	<b>: GB; Great Britain/IE; Ireland</b>	<b>: GB; Great Britain/IE; Ireland</b>
Product identification no	: 0063CM3684	: 0063CM3684
Type of appliance under CE-norm	: C <sub>11</sub> / C <sub>31</sub> / C <sub>31S</sub>	: C <sub>11</sub> / C <sub>31</sub> / C <sub>31S</sub>
Category of appliance	: I <sub>2H</sub> natural gas G20	: I <sub>3B/P</sub> butane/propane G30/G31
Nominal heat input (Gross calorific value)	: 11.7 kW	: Butane (G30) : 11.5 kW Propane (G31) : 9.5 kW
Nominal heat output	: 9.0 kW	: 7.3 - 8.8 kW
Efficiency class	: 1 (85%)	: 1 (85%)
NOx-class	: 5	: 5
Gas rate (max.)	: 1.10 m <sup>3</sup> /hr.	: Butane (G30) : 860 gr/hr. Propane (G31) : 700 gr/hr.
Supply pressure	: 20.0 mbar	: Butane (G30) : 37.0 mbar Propane (G31) : 37.0 mbar
Burner pressure (max.) Hot	: 11.2 mbar(*)	: 29.0 mbar(*)
Burner pressure (max.) Cold	: 10.5 mbar(**)	: 29.0 mbar(**)
Burner pressure (min.)	: 0.9 mbar(***)	: 1.0 mbar(***)
Primary air inlet burner Rear	: 1x Ø12.0 mm	: 1x Ø20.0 <sup>corner</sup> mm + 2x Ø5.0 mm
Primary air inlet burner Front	: 1x Ø12.0 mm	: 1x Ø20.0 <sup>corner</sup> mm + 2x Ø5.0 mm
Gas regulator block (remote control)	: Mertik GV 60	: Mertik GV 60
Main burner	: Line Fire 561x130 mm	: Line Fire 561x130 mm
Main burner injector Rear	: no 190 (= 1x Ø1.90 mm)	: nr. 110 (= 1x Ø1.10 mm)
Main burner injector Front	: no 230 (= 1x Ø2.30 mm)	: nr. 130 (= 1x Ø1.30 mm)
Pilot light burner	: SIT 0.145.019	: SIT 0.145.019
Pilot light burner injector	: no 36 (SIT 0.977.091)	: no 23 (SIT 0.977.150)
Gas connection	: 3/8" G / Ø12 mm	: 3/8" G / Ø12 mm
Concentric flue system connection	: Ø100 mm - Ø150 mm or Ø130 mm - Ø200 mm	: Ø100 mm - Ø150 mm or Ø130 mm - Ø200 mm

<b>Model</b>	<b>: CORNER BELL SMALL 3 L/R LF (Line Fire)</b>	
<b>Gas</b>	<b>: NATURAL GAS</b>	<b>: BUTANE / PROPANE</b>
<b>Country</b>	<b>: GB; Great Britain/IE; Ireland</b>	<b>: GB; Great Britain/IE; Ireland</b>
<b>Batteries remote control</b>		
- Receiver	: 4x 1.5V AA	: 4x 1.5V AA
- Hand-transmitter	: 1x 9V block	: 1x 9V block
<b>Weight:</b>		
- Basis model: Hidden Door	: 82 kg	: 82 kg
- Model: Hidden Door with 10 cm frame and mantle iron	: 94 kg	: 94 kg
- Option: Convection package	: 11 kg	: 11 kg

(\*) : Both burners at maximum. Appliance is on temperature.

(\*\*) : Both burners at maximum. Appliance is cold.

(\*\*\*) : Both burners at minimum.

Flue gas exhaust and combustion air supply:

Roof-mounted outlet : Concentric flue system Ø100 mm - Ø150 mm. Rigid and/or flexible.

Horizontal wall outlet : Concentric flue system Ø130 mm - Ø200 mm. Rigid.

With wall outlet, depending on the flue configuration; Ø100 mm - Ø150 mm or  
Ø130 mm - Ø200 mm.

Heat changing surface: Entire front of the appliance.



## 8 REPLACEMENT PARTS LIST

When requesting service or ordering replacement parts, please quote the model type and serial number. All parts listed in this manual may be ordered from a Bellfires dealer.

No	Article no	Description
1	335118	Main burner "Centre Fire" 561 x 130 mm <u>Natural gas G20 / Butane/Propane G30/G31</u> G20: 1x Ø12.0 mm front + 1x Ø12.0 mm rear G30/G31: 1x Ø20.0 <sup>+corner</sup> mm + 2x Ø5.0 mm front and 1x Ø20.0 <sup>+corner</sup> mm + 2x Ø5.0 mm rear
2	335114	Burner mat L = 561 mm "Centre Fire"
3	334988	Burner injector <u>Natural gas</u> ; Front: no 190 (1x Ø1.90 mm)
4	334988	Burner injector <u>Natural gas</u> ; Rear: no 190 (1x Ø1.90 mm)
5	335122	Burner injector <u>Butane/Propane</u> ; Front: no 125 (1x Ø1.25 mm)
6	335120	Burner injector <u>Butane/Propane</u> ; Rear: no 95 (1x Ø0.95 mm)
7	335119	Main burner "Line Fire" 561 x 130 mm <u>Natural gas G20 / Butane/Propane G30/G31</u> G20: 1x Ø12.0 mm front + 1x Ø12.0 mm rear G30/G31: 1x Ø20.0 <sup>+corner</sup> mm + 2x Ø5.0 mm front and 1x Ø20.0 <sup>+corner</sup> mm + 2x Ø5.0 mm rear
8	335115	Burner mat L = 561 mm "Line Fire"
9	334989	Burner injector <u>Natural gas</u> ; Front: nr. 230 (1x Ø2.30 mm)
10	334988	Burner injector <u>Natural gas</u> ; Rear: nr. 190 (1x Ø1.90 mm)
11	301928	Burner injector <u>Butane/Propane</u> ; Front: nr. 130 (1x Ø1.30 mm)
12	334992	Burner injector <u>Butane/Propane</u> ; Rear: nr. 110 (1x Ø1.10 mm)
13	333597	Gas regulator block; GV 60 (M10 Thermocouple connection)
14	302122	3/8" male x 12 Compression fitting
15	302084	Nut Ø8 mm for burner supply GV 60 for "front burner"
16	302089	Olive Ø8 mm for burner supply GV 60 for "front burner"
17	333607	Gas valve "rear burner"
18	333608	Adapter 3/8"bsp x 3/8"+ O-ring
19	333610	Nut Ø8 mm for gas valve "rear burner"
20	333611	Olive Ø8 mm for gas valve "rear burner"
21	302086	Cut-off nipple Ø4 mm GV 60
22	333601	Cable (sw): Receiver - Thermocouple interrupter, L = 500 mm
23	333602	Cable (tc): Receiver - Thermocouple interrupter, L = 500 mm
24	333598	Hand-held transmitter: Display screen: Temperature and two programmes
25	333599	Cover battery compartment hand-held transmitter - with imprint: Operating double burner
26	333600	Receiver GV 60 - EU
27	302068	8 Wire connecting cable Gas regulator block - Receiver, L = 500 mm
28	302421	Piezo ignition cable, 2x $\sphericalangle$ 2.8 x 0.8 mm, L = 1500 mm

No	Article no	Description
29	321926	Thermocouple M10 - 1500 mm
30	333604	Thermocouple interrupter M10
31	310908	Pilot light set outer casing, Double flame
32	310909	Packing pilot light set outer casing
33	310910	Pilot light injector; <u>Natural gas</u> ; no 36
34	310912	Pilot light injector; <u>Butane/Propane</u> ; no 23
35	310907	Piezo electrode for pilot light, 2.8 x 0.5 mm
36	302062	Nut piezo electrode
37	319842	Nut thermocouple
38	332552	Pilot light olive; Ø4 mm, steel
39	332553	Pilot light nut; Ø4 mm, steel
40	322552	Pilot light pipe; Ø4 mm, L = 1500 mm, Flexible, Stainless steel
41	325750	Burner pipe; Ø8 mm, L = 1500 mm, Flexible, Stainless steel - 10 kW+, "front burner"
42	325750	Burner pipe; Ø8 mm, L = 1500 mm, Flexible, Stainless steel - 10 kW+, "rear burner"
43	326055	Nut; Ø8 mm, compression elbow main burner
44	326054	Olive; Ø8 mm, compression elbow main burner
45	334370	Glass Corner Bell Small 3 front (517 x 716 x 4 mm)
46	334369	Glass Corner Bell Small 3 side (517 x 328 x 4 mm)
47	301669	Tube ceramic glue
48	301593	Black fibre glass tape 15 x 3 mm, adhesive
49	319664	Black fibre glass tape 30 x 2 mm, adhesive
50	311006	Black fibre glass tape 20 x 2 mm, adhesive
51	301617	Black fibre glass cord Ø10 mm

Logs - Chips of wood - Embers - Vermiculite granules - Marble pebbles

Appliance	Log set		Chips of wood set								Embers with Glow-effect Anthracite	Vermiculite no 4 black filtered	Marble pebbles set (white)	Marble pebbles set (grey)		
	Set	Log no	1	2	3	4	5	6	7	8	3 pieces	Bag: 125 gr.	301863	Bag: 50 gr.	310937	Bag: 2,5 kg.
			331357	331358	331359	331360	331361	331362	331363	331364						
			1x	1x	-	1x	-	1x	1x	-						
			1x	1x	-	1x	-	1x	1x	-						
			1x	1x	-	1x	-	1x	1x	-						
			1x	1x	-	1x	-	1x	1x	-						
			1x	1x	-	1x	-	1x	1x	-						
			1x	1x	-	1x	-	1x	1x	-						
	Art. no:															
K 331144		1x	1x	-	1x	-	1x	-	1x	1x	2x	1x	2x	2x	2x	

## 9 DISPOSING OF PACKAGING AND APPLIANCE

The appliance comes in recyclable packaging.

This can include:

- Cardboard
- Wood
- Plastic
- Paper

Such materials must be disposed of responsibly, in line with local regulations.

Batteries should be disposed of as chemical waste. Batteries must be disposed of responsibly, in line with local regulations.

The authorities or fitter can provide you with information on responsible disposal of obsolete appliances.









**Your Bellfires dealer**

01 - 010214 - 335482